



onyX EZR USER GUIDE

Dock & Play Radio



HOME
KIT INCLUDED



Introduction	3
Features	3
Safety and Care Information	4
What's in the Box?	5
Onyx EZR Functions	6
Home Dock	7
Installation	8
Remote Control Functions	8
Remote Control Battery Replacement	9
Step 1: Connect the Home Dock and Dock the Onyx EZR Radio	10
Step 2: Place and Aim the Indoor/Outdoor Home Antenna	11
Step 3: Connect the Home Dock to a Stereo System or Powered Speakers	13
Step 4: Activate	15
Using Your Onyx EZR	16
Main Display screen	16
Navigation Basics	17
Tuning to a Channel	19
Direct Tune	19
Viewing a Category	19
Scanning Channels in a Category	19
Automatically Tuning Channels in Categories	20
Returning to the Main Display Screen	20
Jump and Traffic/Weather	20
Favorite Channels	21
FM Presets	22
Display Screen Mode	22
Parental Controls	23
TuneMix	26
Where Else Can You Use Your Onyx EZR?	28
Configuring Your Onyx EZR	29
Radio ID	29
FM Settings	29
Jump Settings	33
Display Settings	34
Feature Settings	35
Audio Level	36
Parental Controls	36
Signal Indicator	36
Auto Shut Off	37
Factory Settings	37
Restore Defaults	38
Demo Mode	38
Troubleshooting	40
Product Specifications	42
Patent and Environmental Information	43
FCC Statement	44
Copyrights and Trademarks	45
Owners Record	46
Indoor/Outdoor Home Antenna Template	47

Features

Thank you for purchasing the XM Onyx EZR with Home Kit!

SiriusXM Onyx EZR has these exciting features to enhance your overall experience:

- View artist or show name, song or program title and content or channel information on an easy-to-read large high-resolution display
- Store up to 10 of your favorite channels for one touch access
- Create your own music channel that's a blend of channels with TuneMix™
- Easily lock and unlock channels with mature content
- Browse what's playing on other channels while listening to the current one
- One-Touch Jump™ to the previous channel to which you were listening
- Listen in multiple vehicles, at home, in the office or outdoors - all with just one subscription
- Works on the XM network

Please read the entire User Guide before using your Onyx EZR!

Safety and Care Information



IMPORTANT! Self installation instructions and tips are provided for your convenience. It is your responsibility to determine if you have the knowledge, skills, and physical ability required to properly perform an installation. SiriusXM shall have no liability for damage or injury resulting from the installation or use of any SiriusXM or third party products. SiriusXM product warranties do not cover the installation, removal or reinstallation of any product.

- Do not expose to extreme temperatures (above 140°F or below -4°F, or above 60°C or below -20°C).
- Do not expose to moisture. Do not use device near or in water. Do not touch the device with wet hands.
- Do not let any foreign matter spill into device.
- Do not store in dusty areas.
- Do not expose to chemicals such as benzene and thinners. Do not use liquid or aerosol cleaners. Clean with a soft damp cloth only.
- Do not expose to direct sunlight for a prolonged period of time, and do not expose to fire, flame, or other heat sources.
- Do not try to disassemble and/or repair device yourself.
- Do not drop your device or subject it to severe impact.
- Do not place heavy objects on device.
- Do not subject device to excessive pressure.
- If the LCD screen is damaged, do not touch the liquid crystal fluid.

Warning!

- Opening the case may result in electric shock.
- If the liquid crystal fluid comes in contact with your skin, wipe the skin area with a cloth and then wash the skin thoroughly with soap and running water. If the liquid crystal fluid comes into contact with your eyes, flush the eyes with clean water for at least 15 minutes and seek medical care. If the liquid crystal fluid is ingested, flush your mouth thoroughly with water. Drink large quantities of water, and induce vomiting. Seek medical care.
- This product contains chemicals known to the State of California to cause cancer and birth defects or other reproductive harm.

What's in the Box?

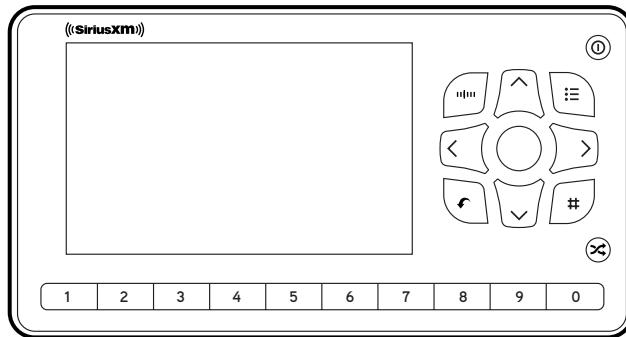

Onyx EZR Radio

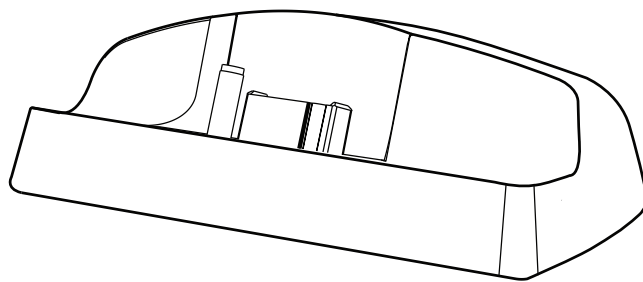

Home Dock

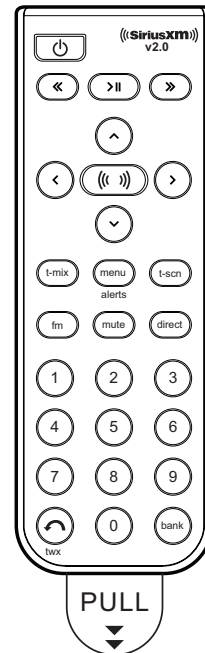

Remote Control

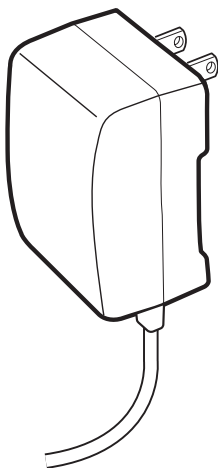

Home Power Adapter

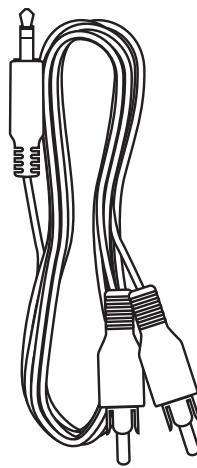

Stereo Audio Cable

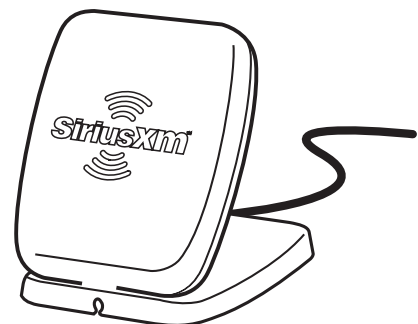

Indoor/Outdoor Home Antenna

Onyx EZR Functions

FM Button

Press to access and cycle through FM presets; **press and hold** to access FM settings.

Up and Down Buttons

Press to preview and tune to channels through the channel lineup; **press and hold** to continuously scroll through channels; also **press** to scroll through lists and highlight items in lists.

Power Button

Press to turn Radio on and off.

Menu Button

Press to access advanced features and configuration options; when in configuration options, **press and hold** to return to main display screen.

Left and Right Buttons

Press to search for channels by category; **press and hold** to continuously scroll through categories.

Select Button

At the main display screen **press** to display and dismiss the favorite channel preview pane; **press** to confirm selection of highlighted item in a menu or list.

Direct Button

Press to enter a channel number using the number buttons and directly tune to the channel.

TuneMix Button

Press to begin TuneMix; **press and hold** to add or remove channels from TuneMix.

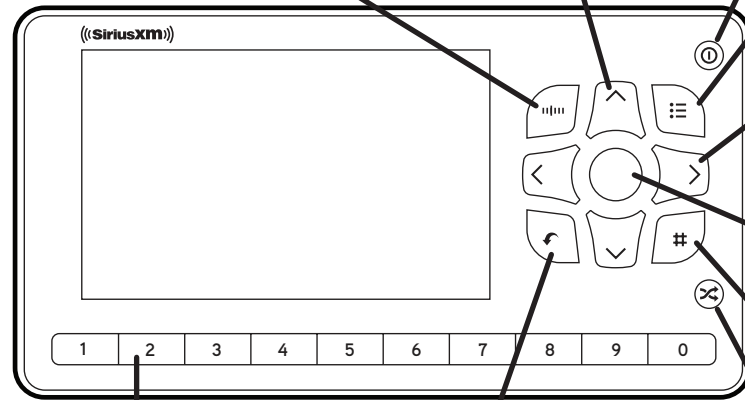

Number Buttons

Press to tune to a stored favorite channel; **press and hold** to store a favorite channel. Also used to enter channel numbers when the Direct button is pressed.

Jump Button

Press to go back to the previous channel to which you were listening; **press and hold** to change display screen mode.

Home Dock

Color-Coded Connections

The color-coded *Home* Dock makes it simple to connect. Just match the colors on the cable ends to the colors on the dock to see what goes where.

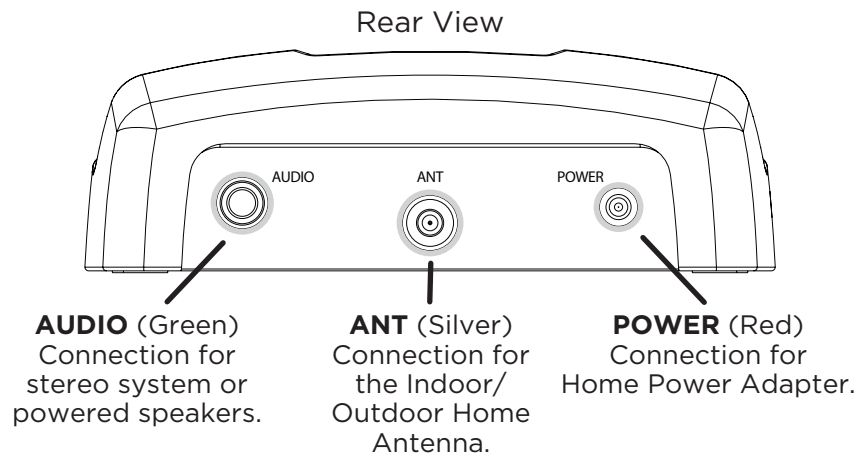

Remote Control Functions

Power Button

Press to turn Radio on and off.

Not Used

Select Button

At the main display screen press to display and dismiss the favorite channel preview pane; press to confirm selection of highlighted item in a menu or list.

TuneMix Button

Press to begin TuneMix; press and hold to add or remove channels from TuneMix.

FM Button

Press to access and cycle through FM presets; press and hold to access FM settings. (Vehicle Dock only).

Number Buttons

Press to tune to a stored favorite channel; press and hold to store a favorite channel; Also used to enter channel numbers when the Direct button is pressed.

Jump Button

Press to go back to the previous channel to which you were listening; press and hold to change display screen mode.

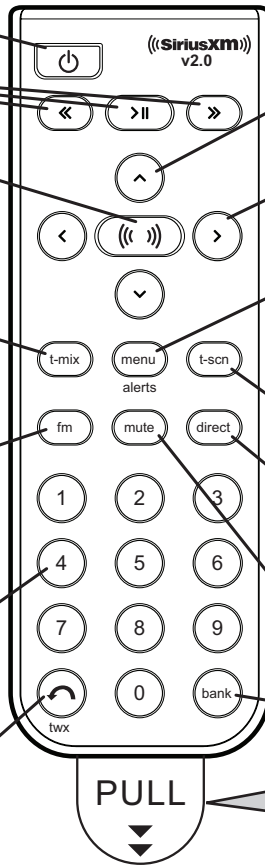

Arrow Buttons Up/Down

Press to preview and tune to channels through the channel lineup; also press to scroll through lists and highlight menu items.

Arrow Buttons Left/Right

Press to search for channels by category.

Menu/Alerts Button

Menu: Press to access advanced features and configuration options; in configuration options, press and hold to return to main display screen.

Alerts: Not used.

TuneScan Button

Not used.

Direct Button

Press to enter a channel number using the number buttons and directly tune to the channel.

Mute Button

Press to silence the audio.

Not Used

IMPORTANT!

Pull tab and remove before using Remote Control.

Remote Control Battery Replacement

The Remote Control has a child resistant battery compartment which requires a pointed object to open the battery compartment. A paper clip is recommended, as shown.

To Replace the Battery:

- 1.** Press the paper clip or other object into the lock release opening on the Remote Control, and slide the battery compartment cover off of the Remote Control.
- 2.** Slide the battery out of the battery compartment.
- 3.** Replace with a new battery. Observe the correct orientation of the battery; the + positive side of the battery should be facing up.
- 4.** Replace the battery compartment cover.

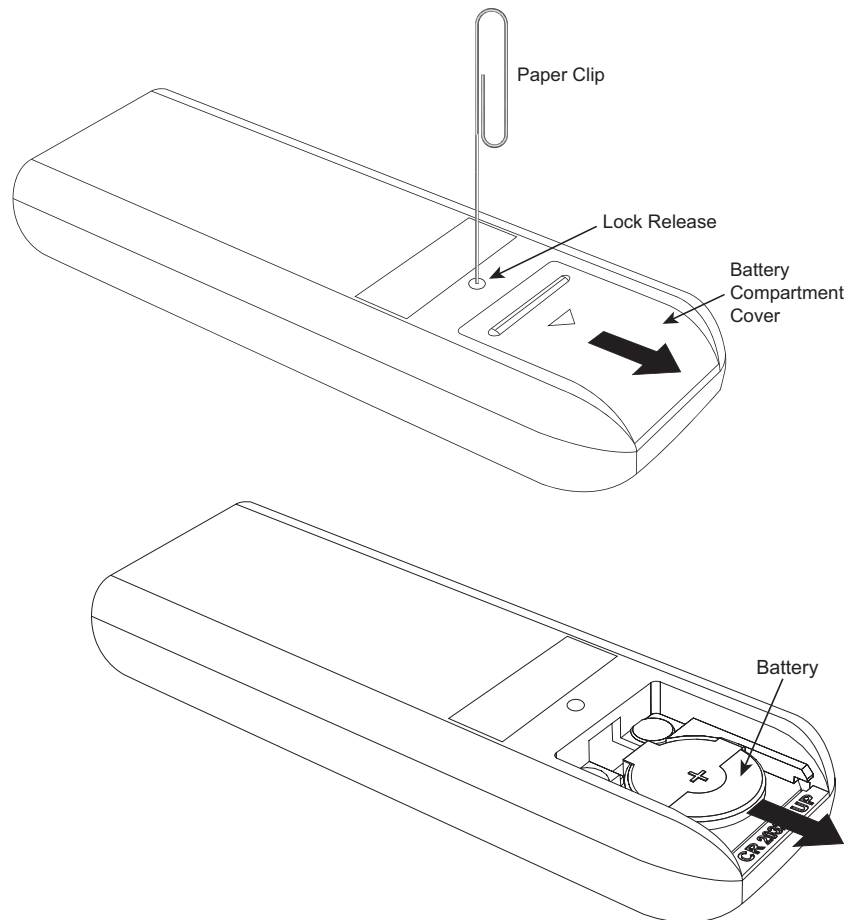

There are several parts to setting up your Home Kit. Follow these 4 steps for an easy installation.

Step 1: Connect the Home Dock and Dock the Onyx EZR Radio

When installing the Home Dock in your home, choose a location in close proximity to your stereo system or powered speakers, and also where the cable from the Indoor/Outdoor Home Antenna can reach the Home Dock. The location should be easily accessible and provide good visibility of the display, but should not be located where it will be in direct sunlight, which will affect the visibility of the display screen.

A. Connect the Indoor/Outdoor Home Antenna

Once you have selected a location, connect the antenna to the **silver ANT** connector at the rear of the Home Dock.

We will work on the location and aiming of the antenna in the next step.

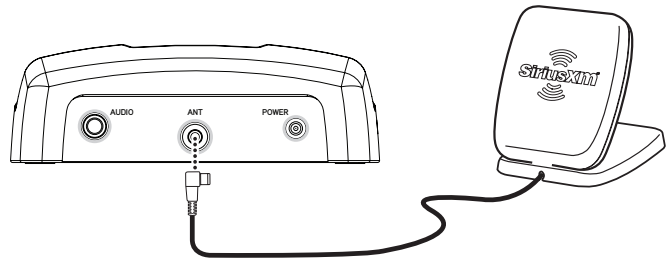

B. Connect the Home Power Adapter

Connect the Home Power Adapter to the **red Power** connector at the rear of the Home Dock, and plug it into a wall outlet.

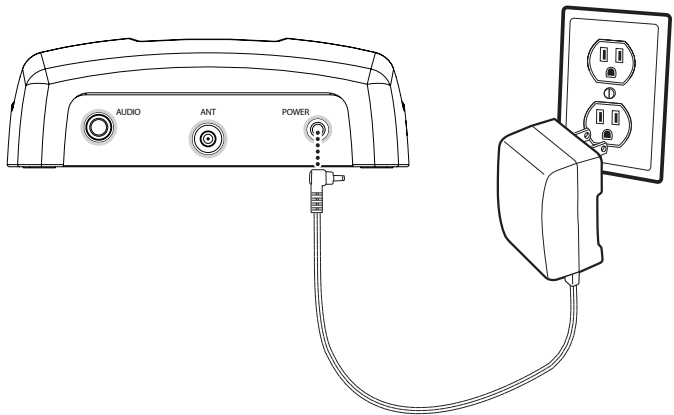

C. Dock the Onyx EZR Radio

Place your Onyx EZR Radio into the Home Dock and press the **Power button** to turn it on.

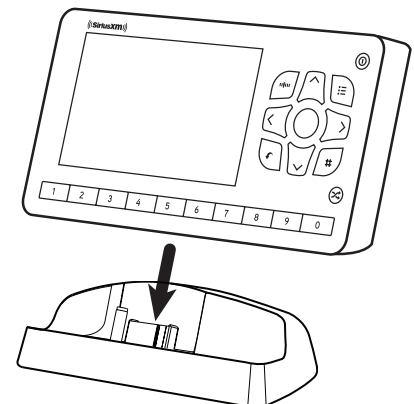

Step 2: Place and Aim the Indoor/Outdoor Home Antenna

To begin, try experimenting with the Indoor/Outdoor Home Antenna to get a feel for the reception in your location. In major metropolitan areas, you might find that you get great reception in several locations without worrying too much about aim and placement. If two to three bars of signal strength are being displayed at the lower left corner of the screen, continue with step 3 on page 13.

If there is not at least two bars of signal strength displayed, refer to “Signal Indicator” on page 36 and access the **Signal Indicator** screen to see a visual indication of signal strength. Move the antenna around the room or from room to room. Aim it from different windows. If you find a location where you are receiving good Satellite or Terrestrial signal strength (or both), press and hold **menu** to exit the Signal Indicator screen. Onyx EZ should be tuned to channel 1, the XM Preview channel. Continue with the step 3 on page 13.

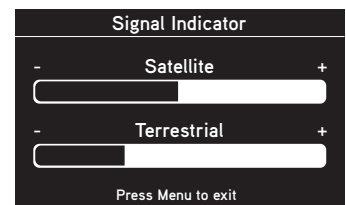

If you are unable to find a location where you are receiving good Satellite or Terrestrial signal strength, try some of the suggestions which follow.

Other Indoor/Outdoor Home Antenna Installation Suggestions



NOTE! If the signal reception is low, intermittent, or **Acquiring Signal** is displayed, after a period of time Onyx EZR may enter demo mode. Demo mode is a feature for retail display purposes, and Onyx EZR will automatically exit demo mode once it begins to receive a good signal. To exit demo mode immediately, press and hold the **Select button** for 10 seconds. Demo mode can be disabled, if desired, by following the instructions in “Demo Mode” on page 38.

Try moving the Indoor/Outdoor Home Antenna closer to a window, ideally one that is facing due south.

Not sure which way is south? Think about where the sun rises (in the east) and sets (in the west). Then stand so that east is to your left and you’ll be facing south. Is there a window in the direction you’re facing? Move the antenna closer to the window.

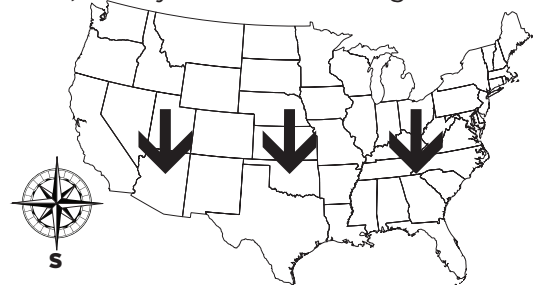

TIP! Still not sure which way is south or where to place your Indoor/Outdoor Home Antenna? Look up your location on an online mapping website that offers satellite views of street addresses where you can easily see which way is south, and what window may offer an unobstructed view of the sky.

Another easy method is to start at any window, then work from window to window in a simple pattern to find the window gives the best signal strength. Note that the antenna must also have an unobstructed view, with no trees or buildings blocking its aim. If the antenna is aimed through a window, be aware that blinds, screens, or any other non-glass elements such as thermal insulation can sometimes cause reception issues. If this is the case, you may want to use another window or place the antenna outside of the window.

If you find a window that gives you good signal strength, you can place the antenna on the windowsill. The antenna may need to be placed on something to raise it above the level of the window frame.

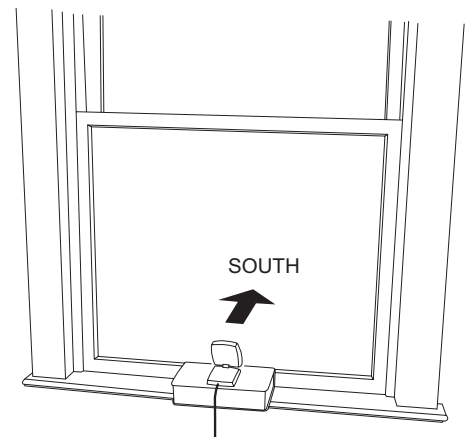

If you don't have a window where you receive a consistent signal, or placing the antenna in a window is not a practical solution for you, **BETTER** reception can be achieved by placing the antenna outside on a window ledge, porch, table, or patio. The location you choose should provide the antenna with a clear view of the southern sky.

If none of the previous solutions work for you, then the **BEST** reception can be achieved by mounting the antenna outdoors, with a clear view of the southern sky.

Note that you will want to consider any potential hazards when you choose the mounting location, and possibly consider professional installation. Sirius XM Radio Inc. is not liable for any damages.

To mount the antenna, you will need four screws (not included) with a 1/4" head (e.g., an M3 screw), and that are suitable for the material onto which you are affixing the antenna, (e.g., wood, metal, etc.). The screws should be spaced 1-3/8" apart horizontally and 1-1/8" vertically. Refer to the template on "Indoor/Outdoor Home Antenna Template" on page 47.

Once you have found a suitable location for the antenna, route the antenna cable to the Home Dock. Be sure you avoid any obstructions that could crimp, kink, or twist the cable. Use protective grommets wherever rough openings are encountered. If the antenna is installed outdoors, route the cable from the antenna location to the interior of the home, working the cable through the basement, under a window sill, etc., and make adjustments to take up cable slack as necessary. Reconnect the antenna to the **silver ANT** connector at the rear of the Home Dock.



TIP! If your Indoor/Outdoor Home Antenna's cable isn't long enough, visit www.siriusxm.com/accessories, or your favorite retailer, and consider a 50 ft. Home Antenna Extension Cable or a Wireless Home Signal Repeater.

Verify that the antenna is pointed south, and that the antenna's view of the sky is not blocked by a tree, a building, a bridge, or anything else. Try various locations until you find one where you are receiving a good signal.

The Indoor/Outdoor Home Antenna's reception can also be tweaked by opening or closing the antenna clamshell, and turning the antenna. While observing the signal strength, make small adjustments to the angle of tilt of the clamshell until the highest possible signal strength is achieved. If you have not wall-mounted the

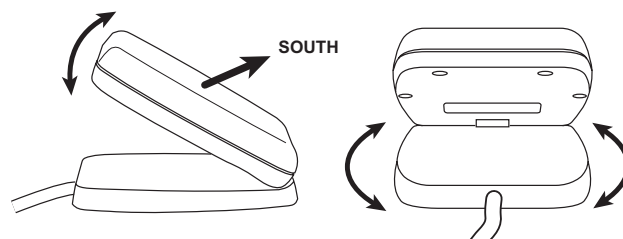
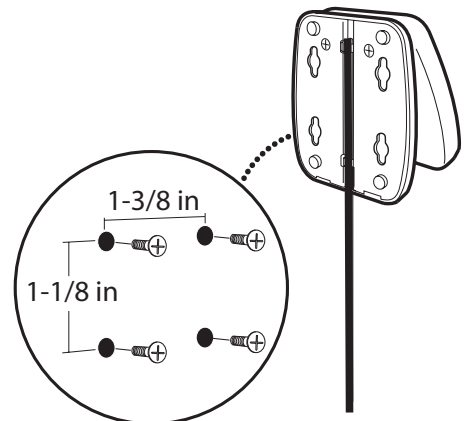
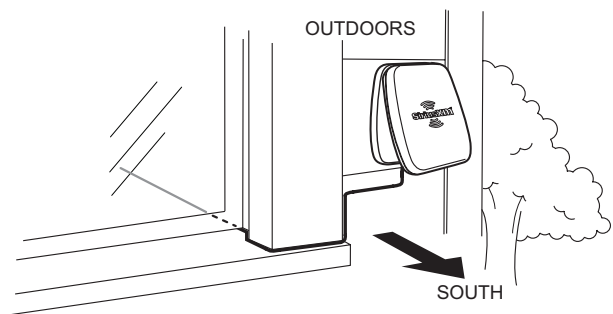
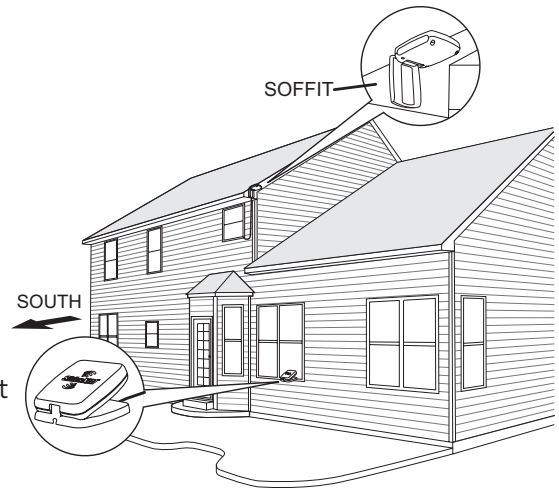

antenna, turn the antenna slightly to the right or left and observe if the signal strength increases. For each tweak, allow a few seconds in each position to determine if the signal strength increases.

If either the Satellite or the Terrestrial signal bar (or both) are more than half filled, you are receiving a good signal and are done aiming the antenna. Exit the **Signal Indicator** screen by pressing and holding **menu**. If Onyx EZ is displaying channel 1, the XM Preview channel, with two to three bars of signal strength displayed at the lower left of the screen, continue with the next step, otherwise, continue trying other locations for the antenna.

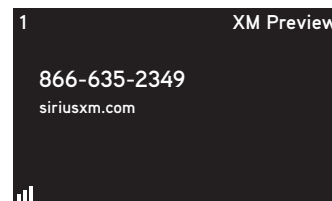

Step 3: Connect the Home Dock to a Stereo System or Powered Speakers

The Home Dock can be connected to your stereo system, or to a set of powered speakers. If you are connecting to a stereo system, see the following section. If you are connecting to a set of powered speakers, see “To Connect the Home Dock to Your Powered Speakers” on page 13.

To Connect the Home Dock to Your Stereo System

The Home Dock can be connected to your stereo system through the **AUX In** or **LINE In** connection of your stereo system, using the provided Stereo Audio Cable.

1. Take the provided Stereo Audio Cable and connect the single 1/8” (3.5 mm) connector to the **green AUDIO** connector at the rear of the Home Dock.
2. Connect the white left and red right Stereo Audio Cable connectors (“L” and “R” are also on each respective tip) to any available input other than PHONO on your stereo system. (If your stereo’s inputs are marked red and black, simply connect the white plug to the black input.)

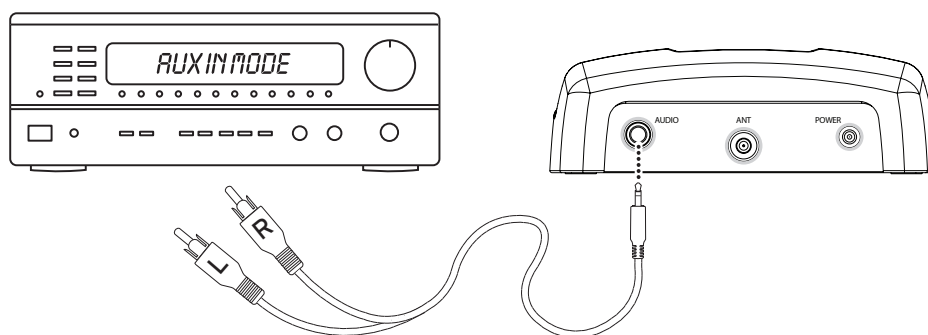

3. Turn the stereo system On, and make sure you select the correct input on your stereo system for the **AUX In** or **LINE In** connection.
4. If you have connected everything correctly, and you are receiving the XM signal, you should hear the XM audio from channel 1.
5. The audio level of your Radio can also be adjusted, if necessary. Refer to “Audio Level” on page 36 to adjust the audio level. The installation is complete.

To Connect the Home Dock to Your Powered Speakers

The Home Dock can be connected directly to a set of powered speakers.

1. Connect the 1/8” (3.5 mm) connector from the powered speakers to the **green AUDIO** connector at the rear of the Home Dock.
2. Plug the powered speakers into a wall outlet.
3. Turn On the powered speakers.

4. If you have connected everything correctly, and you are receiving the XM signal, you should hear the XM audio from channel 1.

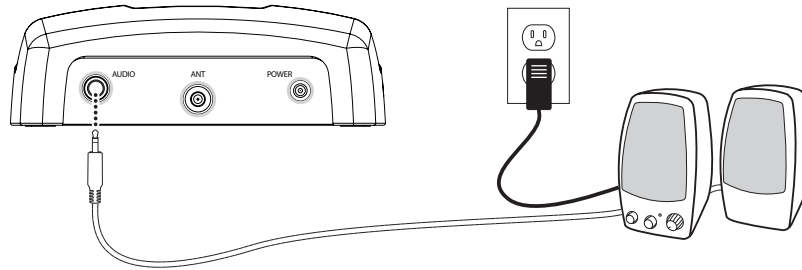

5. The audio level of your Radio can also be adjusted, if necessary. Refer to “Audio Level” on page 36 to adjust the audio level. The installation is complete.

Step 4: Activate

You can follow either the general activation and subscription process or use the on-board activation guide to activate your Onyx EZR and subscribe to the XM service.

General activation and subscription process:

Subscribe to the XM service by following these steps:

1. Make sure your Onyx EZR is turned on, tuned to XM Preview channel 1, and receiving the XM signal so that you can hear the XM audio.
2. Make a note of the XM Radio ID. You can find it:
 - by selecting **Radio ID** in menu items
 - on channel 0 (zero)
 - on a label on the bottom of the gift box
 - on the label on the back of your Onyx Plus



NOTE! The XM Radio ID does not use the letters I, O, S, or F.



*The phone number show above may differ from the one shown on your Onyx EZR. All numbers are valid.

3. To subscribe:
 - Online: Go to **www.siriusxm.com/activatenow** to access or set up an online account, subscribe to the service, and activate your Radio.

OR

 - By phone: Call **1-866-635-2349**.

Activation usually takes 10 to 15 minutes after you have completed the subscription process, but may take up to an hour. We recommend that your Radio remain on until subscribed. Once subscribed, the Radio will receive and you can tune to channels in your subscription plan.

Press **up ▲** or **down ▼** to tune to other channels, and **left ◀** or **right ▶** to browse the different categories of channels. Learn what all the buttons do by turning to “Navigation Basics” on page 26.

Activation guide:

For your convenience, Onyx EZR has an on-board activation guide. You can activate your radio and subscribe to the XM service by using this guide, where you will be guided step-by-step through the subscription process. To access and use the guide, simply follow these steps:

1. Turn Onyx EZR on and press the **Menu button**.
2. **Activate Radio** will be highlighted. Press the **Select button**.
3. Follow the directions on each successive screen until you complete the subscription process.

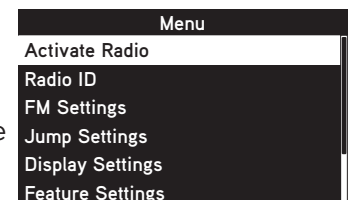

Main Display screen

When listening to a channel, information about the channel and what is currently playing is displayed on the screen.

The favorite channel preview pane can be toggled by pressing the **Select** button at the main display screen. Press once to display the first five favorite channels, press again to display the second five favorite channels, and press again to close the preview pane.

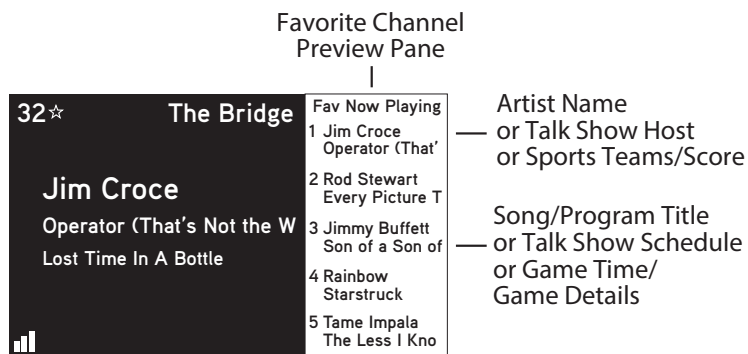
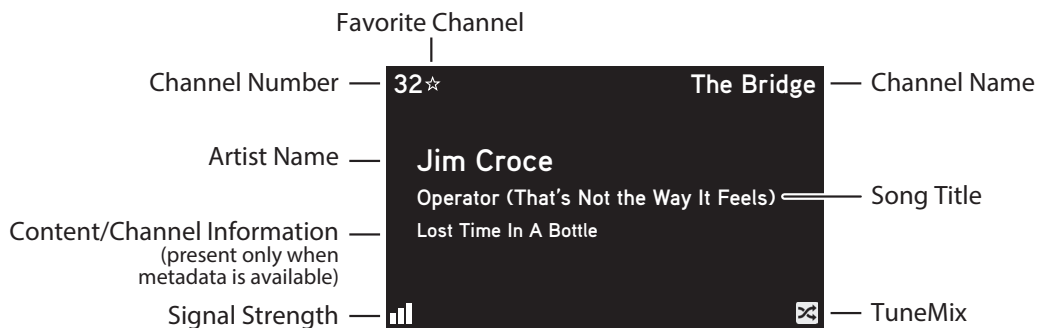
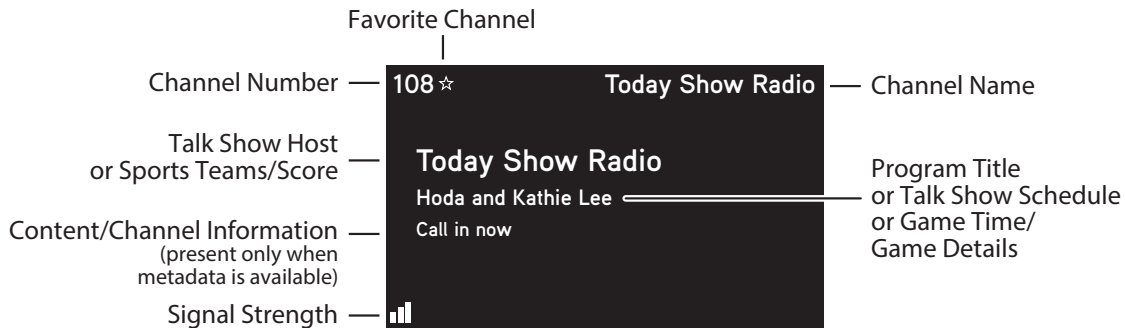

Navigation Basics

Power Button



Pressing the **Power button** turns Onyx EZR On or Off.

Navigation Buttons

Pressing **Left**, **Right**, **Up**, and **Down** navigates through various features and functions of Onyx EZR.

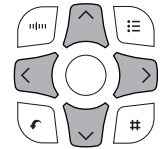

Left ◀ or Right ▶ button: Displays the channel categories such as Rock, Pop, Sports, Talk/News, etc. Repeated presses cycle through the categories one at a time. Also, decreases or increases the settings of various menu options such as Brightness, Audio Level, etc.

Up ▲ or Down ▼ button (press and release): Immediately tunes to the next or previous channel in the channel lineup. Also, scrolls through lists and highlights an item in the list.

Up ▲ or Down ▼ button (press and hold): Continuously scrolls through any list. While on the main display screen, continuously scrolls through the channel lineup and briefly displays the information of each channel. When the button is released, Radio tunes to the last channel it had scrolled to in the channel lineup.

Select Button

Pressing the **Select button** displays and dismisses the favorite channel preview pane at the main display screen.

Pressing the **Select button** selects a highlighted item in a list and confirms settings.



Menu Button

Pressing **Menu** displays various options to make setup and feature changes. Pressing **Menu** when in menu options returns to the previous menu option screen until menu options is exited. Pressing and holding **Menu** returns to the main display screen in most instances.



FM Button

Pressing **FM** provides easy tuning of FM presets for optimized *PowerConnect* performance. Repeatedly pressing **FM** displays and cycles through the list of preset FM channels one at a time. The Radio automatically tunes to the displayed FM channel. Pressing and holding **FM** accesses the FM Settings menu. It is not available when Aux In Cable or Cassette Adapter is used for audio connection.



Jump Button

Depending on how it is configured, pressing **Jump** either tunes to the previous channel that was being played, or tunes to the channel broadcasting traffic and weather conditions of a city of your choice which has been selected from a list of cities.

Pressing and holding **Jump** toggles the display screen between black background with white text and white background with black text.



Direct Button

Pressing **Direct** prompts for the entry of a channel number using the number buttons. Once the channel number is entered, the Radio directly tunes to the new channel.



TuneMix Button

Pressing **TuneMix** puts the radio in TuneMix mode where the radio plays songs in a unique mix from the music channels you have selected for TuneMix. Pressing and holding **TuneMix** displays the TuneMix channel list where you can add or remove channels from TuneMix.



Number Buttons



Each number button stores a favorite channel in its button location and provides one touch access to tune the channel. Number buttons also directly tune to a channel when the channel number is entered after pressing **Direct**.

Tuning to a Channel

Press and release ▲ and ▼ to immediately tune to the next or previous channel.

Press and hold ▲ and ▼ to quickly scroll through the channels. Release to tune to the channel that is displayed.

Direct Tune

A channel can be tuned directly by entering the channel number using the number buttons.

1. To directly tune to a channel press **Direct**.
2. Use the number buttons **0-9** to enter the channel number and wait until the channel is tuned, or press the **Select button** to immediately tune to the channel. If you make a mistake while entering the channel number, press ◀ to delete the number that was entered.

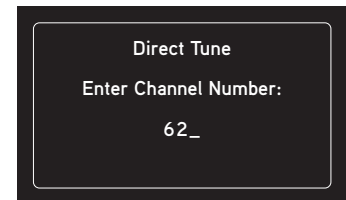

Viewing a Category

Channels are organized into categories to make it easier for you to find channels, such as Sports, Country, Kids, Rock, etc.

In addition to the regular categories, there is special category for Favorite channels. If you have saved favorite channels, when you press ◀ from the main display screen the Favorites category is shown. Also, if you are tuned to a favorite channel, when you press ▶ the Favorites category is the first category shown.

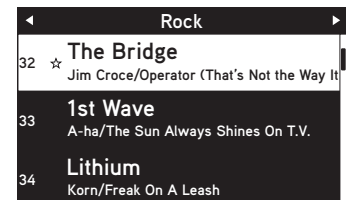

To view categories:

3. To view channels in a category in a list press ◀ or ▶.
4. Scroll through the channels in a category by using ▲ and ▼ to find the channel you want to tune. Press the **Select button** to tune to a highlighted channel, or press ◀ or ▶ to view channels in the previous or next category.



TIP! To briefly listen to each channel in the category, scroll to and highlight Scan at the end of the category list and press the **Select button**. Refer to "Scanning Channels in a Category" on page 19 to learn more about Scan.

Scanning Channels in a Category

You can scan a category and listen to each channel for 10 seconds as Onyx EZR automatically tunes to each channel in the category. If you want to stay tuned to the channel being played and stop the scan, just press the **Select button**.

To scan a category:

1. Press ◀ or ▶ until the desired category is displayed.
2. Scroll down and highlight the last item in the category which will be **Scan** and the category name.

3. Press the **Select button**. The scan will begin.
4. Press the **Select button** to stop the scan and to continue to listen to the channel currently being played, or press ▼ or ▲ or **menu** to return to the channel you were listening to before you began the scan.



Automatically Tuning Channels in Categories

Onyx EZR can be configured to automatically tune channels when browsing a category list, when you highlight a channel in the list and pause for a few seconds. This feature can be turned off so that channels are not tuned automatically if desired.

To turn channel browsing auto select on/off:

1. Press **Menu**.
2. Press ▼ to scroll to and highlight **Feature Settings**. Press the **Select button**.
3. Press ▼ to scroll to and highlight **Channel Browsing Auto Select**. Pressing the **Select button** will toggle between **On** and **Off**.
4. Press and hold **Menu** to return to the main display screen.

Returning to the Main Display Screen

Pressing and holding **Menu** in most instances will return you to the main display screen. In some instances, you may need to follow the instructions on the display screen.

Jump and Traffic/Weather

Depending upon how you configure the mode, pressing **Jump** will either go to the previous channel to which you were listening, or go to the traffic and weather channel for the city of your choice, which you select from a list of cities.

Pressing and holding **Jump** toggles the display screen between black background with white text and white background with black text.

If Jump is set to **Last Channel**, pressing **Jump** will immediately tune to the previous channel to which you were listening.

If Jump is set to **Traffic/Weather**, when you press **Jump** the channel with the traffic and weather for the city you selected will be tuned. If the traffic/weather broadcast of your selected city is not immediately available, a message will be displayed at the bottom of the screen to indicate that a jump is pending. Once the traffic/weather report is ready to be broadcast,

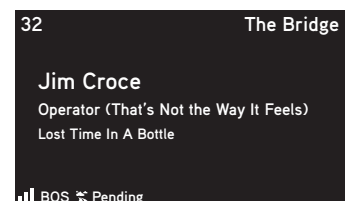

the Radio will automatically tune to the traffic/weather channel. Since a channel may broadcast the traffic and weather reports of more than one city, you may have to wait a few minutes for the broadcast of your selected city.

Pressing **Jump** while a traffic/weather jump is pending will cancel the jump. Pressing **Jump** after the Radio has tuned to the traffic/weather channel will return back to the channel to which you had been listening immediately prior to pressing **Jump**.



TIP! By default **Jump** is configured to tune to the previously tuned channel. To configure **Jump** for traffic and weather and select a city, refer to “Jump Settings” on page 33.

Favorite Channels

You can select up to 10 of your favorite channels so you can easily tune to them. Each favorite channel can be assigned to a number button.

To assign or replace a favorite channel to a number button:

1. Tune to the desired channel.
2. Press and hold a number button between **0-9** that you want to assign to that favorite channel. An advisory with the channel number and name will be displayed on the screen confirming that the channel has been assigned.
3. If a favorite channel is already assigned to the number button, an advisory will be displayed prompting you to replace the favorite channel, or to cancel. Press the **Select button** to replace the favorite channel, or **Menu** to cancel the replacement.

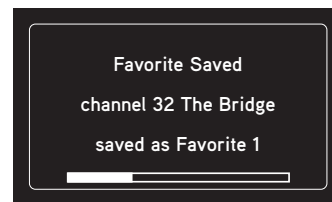

To listen to a favorite channel:

1. Press the number button between **0-9** that was assigned to the desired favorite channel. Onyx EZR will tune to the favorite channel.



TIP! When you are at the main display screen, press **◀** to see your list of favorite channels. Scroll to highlight a favorite channel and press the **Select button** to listen to that channel.

To erase all favorite channels:

All favorite channels which have been previously saved can be erased all-at-once.

1. Press **Menu**.
2. Press **▼** to scroll to and highlight **Feature Settings**. Press the **Select button**.
3. Press **▼** to scroll to and highlight **Erase all Favorite Channels**. Press the **Select button**.
4. You will be prompted that all favorite channels are about to be erased. Press the **Select button** to erase all favorite channels, or **Menu** to cancel.
5. Press and hold **Menu** to return to the main display screen.

FM Presets

FM presets make it easy to quickly access stored FM channels and choose a new FM channel from the saved presets.

FM presets are used when you use *PowerConnect* or the FMDA to listen to your Onyx EZR through your vehicle's FM radio. (Vehicle Dock Only.)

To use a different FM preset:

1. Press **FM** to display the current FM preset.
2. To display and select the next FM preset, press **FM** again. The Radio will tune to the displayed FM channel. If the preset is the one you want, press **Menu** or wait for the screen to time out.
3. Repeatedly pressing **FM** will cycle through the FM presets.
4. Set your vehicle's FM radio to the same FM channel.



IMPORTANT! You need to ensure that your vehicle's FM radio is tuned to the same FM channel.



TIP! To configure the list of preset FM channels, you need to find available FM channels in your area. Refer to "Find Available FM Channels in Your Area" on page 29. Next, refer to "Set and Select an FM Channel" on page 30.



Display Screen Mode

The display screen on the Onyx EZR can be adjusted to display a black background with white text, or a white background with black text.

To switch between display modes:

1. At the main display screen (when not in TuneMix), press and hold the **Jump** button until the display screen changes mode. Repeat to toggle between the display screen modes.

White text on a black background

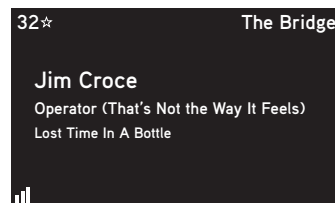

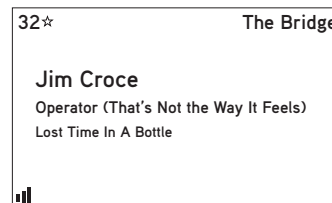

Black text on a white background





The display mode can also be adjusted through the menu settings. Refer to "Display Settings" on page 34.

Parental Controls



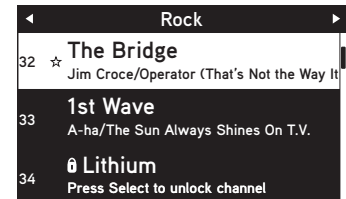

Onyx EZR has a parental control feature which allows you to lock access to individual channels, or lock access to an entire category. A 4-digit lock code controls access to the locked channel or locked category.

When you browse a category, the channel number and name of the locked channel will be shown but not the artist and song/program information. Instead, a lock icon  and “Press Select to unlock channel” is shown. If you tune through the channels using  and , the locked channels are skipped and are neither displayed, nor tuned.





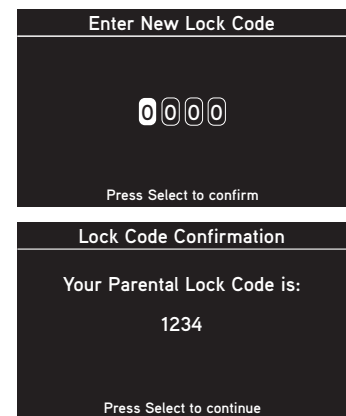

If you attempt to tune to a locked channel, either by using direct tune or through the category list, you'll be prompted to enter the 4-digit lock code. When the correct code is entered, you'll be able to tune to and listen to the channel. All locked channels become unlocked and remain unlocked until you turn Onyx EZR Off and back On. In the category list, the previously locked channels will show an unlocked icon .

To turn Parental Controls on or off):

1. Press **Menu**.
2. Press  to scroll to and highlight **Parental Controls**. Press the **Select button**.
3. If this is the first time you are turning on Parental Controls, **Parental Controls** will be highlighted. Press the **Select button**. You will be prompted to select a 4-digit lock code:
 - i. For each digit, press one of the **0-9** keys (or press  or  to select digits and then press  to advance to the next digit.) Press  if you need to go back and edit a previous digit.
 - ii. When you have selected all 4 digits of your lock code press the **Select button**.
 - iii. The Lock Code Confirmation screen will be displayed. For your records, write down the lock code you have selected. Press the **Select button**. Continue with step 3.



If you had previously selected a 4-digit lock code you will be prompted to enter your lock code:

- i. For each digit, press one of the **0-9** keys (or press  or  to select digits and then press  to advance to the next digit.) Press  if you need to go back and edit a previous digit.
 - ii. When you have selected all 4 digits of the lock code press the **Select button**.
4. At the “Parental Controls” screen, **Parental Controls** will be highlighted. Press the **Select button** to turn parental control On (or press the **Select button** to turn parental control Off).
 5. Press and hold **Menu** to return to the main display screen.

To lock or unlock channels or categories:

1. Press **Menu**.
2. Press  to scroll to and highlight **Parental Controls**. Press the **Select button**.

3. You will be prompted to enter the 4-digit lock code. For each digit, press one of the **0-9** keys (or press ▼ or ▲ to select digits and then press ► to advance to the next digit.) Press ◀ if you need to go back and edit a previous digit.
4. When you have entered all 4 digits of the lock code press the **Select button**.
5. If **Parental Controls** is shown as Off, press the **Select button** to turn it On, otherwise continue with the next step.
6. At the “Parental Controls” screen, press ▼ to scroll to and highlight **Locked Channels**. Press the **Select button**.
7. A list of all the categories and the channels in each category will be displayed. Press ▼ and ▲ to scroll to and highlight a channel or category you want to lock. Press the **Select button**. A lock icon  will be displayed to the left of the channel or category you locked.

To unlock a locked channel or category, simply highlight the locked channel or category and press the **Select button**. The lock icon will be removed indicating the channel or category is unlocked.

8. You can continue to lock and unlock as many channels or categories as you wish. When you are finished, press and hold **Menu** to return to the main display screen.

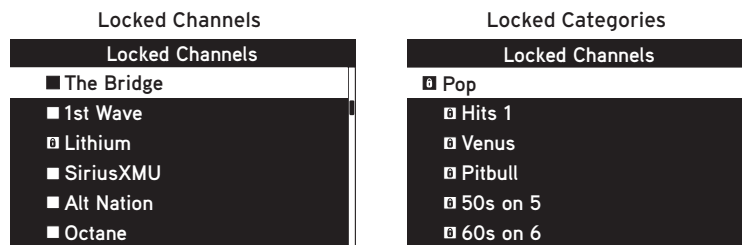

To change your lock code:

1. Press **Menu**.
2. Press ▼ to scroll to and highlight **Parental Controls**. Press the **Select button**.
3. You will be prompted to enter your existing 4-digit lock code. For each digit, press one of the **0-9** keys (or press ▼ or ▲ to select digits keys and then press ► to advance to the next digit.) Press ◀ if you need to go back and edit a previous digit.
4. When you have entered all 4 digits of the lock code press the **Select button**.
5. If **Parental Controls** are shown as Off, press the **Select button** to turn it On, otherwise continue with the next step.
6. At the “Parental Controls” screen, press ▼ to scroll to and highlight **Change My Lock Code**. Press the **Select button**.
7. You will be prompted to enter a new 4-digit lock code. For each digit, press one of the **0-9** (or press ▼ or ▲ to select digits keys and then press ► to advance to the next digit.) Press ◀ if you need to go back and edit a previous digit.
8. The Lock Code Confirmation screen will be displayed. For your records, write down the lock code you have selected. Press the **Select button**.
9. Press and hold **Menu** to return to the main display screen.

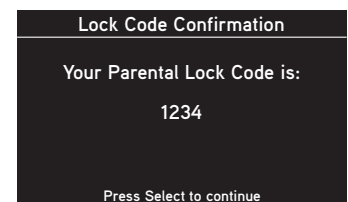

To listen to a locked channel:

There are two ways to tune to a channel which has been locked. The first is to directly tune to the locked channel using **Direct**, and the second is to select the locked channel from a category list.

1. Directly tune to or select the locked channel:

To directly tune to a locked channel:

- i. Press **Direct** and enter the channel number using the **0-9** keys.

To select a locked channel from the category list:

- i. Press ◀ or ▶ to view the category list of the locked channel to which you wish to tune.
 - ii. Press ▼ to scroll to and highlight the locked channel. Press the **Select button**.
2. You will be prompted to enter your existing 4-digit lock code. For each digit, press one of the **0-9** keys (or press ▼ or ▲ to select digits and then press ▶ to advance to the next digit.) Press ◀ if you need to go back and edit a previous digit.
 3. When you have entered all 4 digits of the lock code, press the **Select button**. If your lock code is correct the channel will be tuned. All locked channels become unlocked and will remain unlocked until you turn Onyx EZR Off and back On. In the category list, the previously locked channels will show an unlocked icon 🔒.

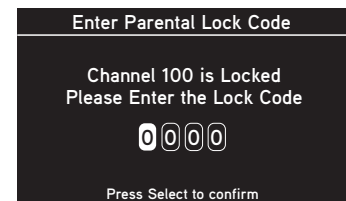

TuneMix

TuneMix plays songs in a unique mix from music channels you have pre-selected, allowing you to build a blended channel from as few as three to as many as 18 music channels.

Tips for Obtaining the Best Experience from TuneMix

Before using the TuneMix feature, familiarize yourself with the following tips to help you obtain the best experience from TuneMix:

- TuneMix plays songs which have aired on the music channels you have selected for TuneMix.
- The more music channels you select for TuneMix, the more songs TuneMix will have to play. For best results, select a minimum of three music channels.
- Certain music channels are not eligible for TuneMix due to the way in which they are broadcast. These music channels are not included in channel selection list for TuneMix.

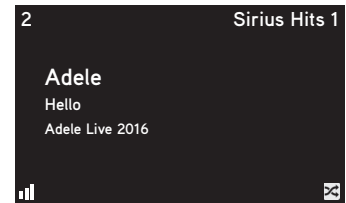

To add or remove channels from TuneMix:

Before you use TuneMix, add a minimum of three music channels to use for TuneMix.

1. Press and hold the **TuneMix** button (or press **Menu**, press ▼ to scroll to and highlight **Feature Settings** and press the **Select** button. **TuneMix** will be highlighted; press the **Select** button. **Edit TuneMix Channels** will be highlighted; press the **Select** button.)
2. Press ▼ or ▲ to highlight a channel in the list and press the **Select** button to add the channel for TuneMix. A selected channel will show an **X** in the box to the left of the channel name.
3. You can also add all the channels in a category by selecting the category name. When the category name is selected, all the channels in the category will be shown as selected for TuneMix.

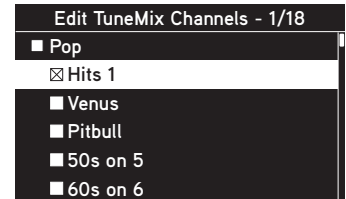

NOTE! if you select to add a category which has more than 18 channels, only up to the first 18 channels in the category are added to TuneMix.

4. You can also remove a channel from TuneMix by highlighting a channel already selected for TuneMix and pressing the **Select** button. The **X** in the box to the left of the channel name will be removed to indicate the channel is no longer selected for TuneMix. You can do the same for an entire category.
5. You can select up to 18 channels for TuneMix. When you have finished adding (or removing) channels, press and hold **Menu** to exit.

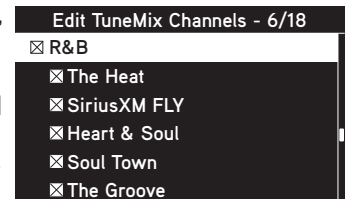

To listen to TuneMix:

1. Press **TuneMix**. TuneMix will begin to play and the TuneMix icon will be displayed on in the lower right corner of the main display screen.
2. You can press ◀ or ▶ to skip back or skip ahead to the previous or next song in TuneMix.

If you have not added any channels for TuneMix, or not have not added

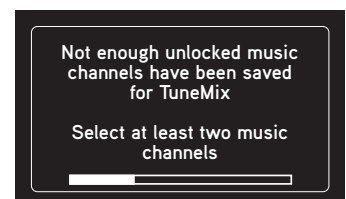

enough channels for TuneMix, or some TuneMix channels are locked by Parental Controls resulting in not enough channels for TuneMix to play, the advisory, **Not enough unlocked music channels have been saved for TuneMix** will be displayed. The TuneMix channel list will automatically be displayed so you can add channels for TuneMix, or highlight a locked channel and unlock the locked channels so they can be used in TuneMix.

To end TuneMix:

There are two ways to end TuneMix:

- If you want to end TuneMix and continue listening to the channel that TuneMix is currently playing, press the **Select button**.
- If you want to return to the channel to which you were listening prior to TuneMix, press and hold the **Select button**.

TuneMix will terminate if you tune another channel, if you press **Jump**, if you press **TuneMix**, if you press the **Direct** button and select a channel, or if you tune to a traffic/weather report.

To erase all channels from TuneMix:

Rather than removing the channels that had been previously selected for TuneMix one-by-one, you can remove all the previously selected channels at once.

1. Press **Menu**, press ▼ to scroll to and highlight **Feature Settings** and press the **Select button**.
2. **TuneMix** will be highlighted. Press the **Select button**.
3. Press ▼ to scroll to and highlight **Erase all Channels from TuneMix** and press the **Select button**.
4. You will be prompted to confirm that you want to erase all the channels that have been selected for TuneMix. Press the **Select button** to erase the channels, or press **Menu** if you do not want to erase the channels.
5. If you selected to erase all the channels, the display will show **0/18** channels selected for TuneMix indicating that no channels are currently selected for TuneMix.
6. Press and hold **Menu** to exit.

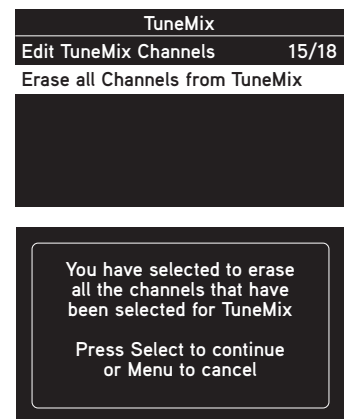

SiriusXM offers a variety of accessories that allow you to adapt your Onyx EZR to your lifestyle and enhance your listening experience. With these accessories, you can effortlessly take your SiriusXM listening experience from your home or office to your vehicle or on the go — all with a single subscription.

- In Your Other Vehicles – With Vehicle Kits, you can enjoy your Onyx EZR in other vehicles.
- In Your Office, Other Homes, etc. – With additional Home Kits, you can play your Onyx EZR through an existing stereo system or powered speakers where you work, or in other homes.
- In Almost Any Location You Like – With a Portable Sound System you have the freedom to listen to your Onyx EZR where and when you want, from your kitchen or den, to the office, to outside on the deck, or at a picnic.

For more information on SiriusXM accessories or to purchase an accessory, please visit your local retailer or www.siriusxm.com/accessories.

Radio ID

Onyx EZR has an 8 character alphanumeric ID which uniquely identifies your Radio. This ID is used during the subscription process.

To display the Radio ID:

1. Press **Menu**.
2. **Radio ID** will be highlighted. If it is not highlighted, press ▼ to scroll to and highlight **Radio ID**. Press the **Select** button. The Radio ID will be displayed.
3. Press and hold **Menu** to return to the main display screen.

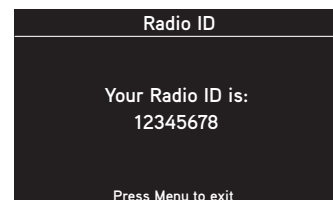

FM Settings

Find Available FM Channels in Your Area

Before attempting any of the procedures below, you should park your vehicle in a safe location. Do not attempt to set up your FM channels or any Onyx EZR function while driving.

PowerConnect allows you to listen to SiriusXM through your existing vehicle radio. You will first need to find an available FM channel, which is a channel that is not being used by an FM radio station in your area. When you tune your vehicle's FM radio to an available channel, you should only hear static or silence – not talk or music.

Once you have found an available FM channel, you'll need to tune Onyx EZR and your vehicle's radio to the same FM channel to receive XM audio through your vehicle's radio.

We recommend one of the following methods to find an available FM channel:

1. Use the SiriusXM FM Channel Finder

Use the SiriusXM FM Channel Finder at www.siriusxm.com/fmchannel. Go to the website and enter your zip code. The Channel Finder will suggest a list of available FM channels in your area. For convenience, write down or print out the list.

Tune Onyx EZR to a favorite XM channel (or to channel 1, if it's not activated). Turn on your vehicle's FM radio. Pick the first FM channel on your Channel Finder list and tune the FM radio to that channel. If you do not hear a local FM station broadcast, then tune Onyx EZR to the same FM channel. (Refer to "Set and Select an FM Channel" on page 30.) You should hear the XM channel through your vehicle's radio. If you are satisfied with the sound quality, you're done! If this FM channel doesn't work well for you, work down the list until you find an FM channel that allows you to hear XM clearly.

OR

2. Manually tune through your local FM channels

Manually tune through your local FM channels on your vehicle's FM radio. Turn on your vehicle's FM radio. Start at 88.1 and use the 'Manual' tune function on your vehicle's FM radio to tune through each FM channel one-by-one (88.1 followed by 88.3 etc.) to locate channels that aren't

being used by a local FM radio station. Write down each FM channel that has only static or silence on it, until you reach 107.9. Once you have created your list of available FM channels, you will need to find the one that provides the best match for Onyx EZR.

Tune Onyx EZR to a favorite XM channel (or to channel 1, if it's not activated). Pick the first FM channel on your list and tune the FM radio to that channel. Then tune Onyx EZR to the same FM channel. (Refer to "Set and Select an FM Channel" on page 30.) You should hear the XM channel through your vehicle's radio. If you are satisfied with the sound quality, you're done! If this FM channel doesn't work well for you, work down the list until you find an FM channel that allows you to hear XM clearly.



NOTE! You may find an FM channel with static or silence that does not work with Onyx EZR. It is possible that some type of inaudible interference is present that prevents reception of the XM broadcast. Your only options are to use another FM channel or a different audio connection method.



TIP! If you regularly drive from one location to another, such as your daily commute, you may need to use different FM channels along your route for best performance. If this is the case, we recommend saving the best FM channels as presets on your FM radio and Onyx EZR. Then you simply select and match the best channel for the area you are in.



TIP! It will be much more difficult to find available FM channels in large cities than in most suburban or rural locations. A direct audio connection using the Aux In Cable, Cassette Adapter, or professional installation is your best solution if you drive in or near large metropolitan areas.



NOTE! The SiriusXM FM Channel Finder relies on data from the Federal Communications Commission. The data may not reflect the latest stations in your area. In addition, local geography and weather conditions can impact reception, so your results may be different from the list.



NOTE! The performance of FM radios are different, based on manufacturer and vehicle style. Some may not work well with the type of FM transmitter used by Onyx EZR. This is why we recommend a direct audio connection using the Aux In Cable or Cassette Adapter if they can be used in your vehicle. Professional installation can also resolve almost any performance issue.

Set and Select an FM Channel

Onyx EZR allows you to easily store (i.e., preset) up to 5 different FM channels. At any time, you can select any one of these 5 FM presets to hear SiriusXM through your existing vehicle radio. Having a choice of 5 FM presets also makes it easy to switch to the appropriate FM channel as you travel from one area to another. Each FM preset is stored in its own storage location. You can easily add or edit the FM preset in any one of the 5 storage locations.



IMPORTANT! Onyx EZR and the vehicle's FM radio need to be tuned to the same FM channel in order to hear the audio.



TIP! The FM 1 storage location is preset with FM channel 97.9.

To set and select an FM preset:

1. Press **Menu**.
2. Press ▼ to scroll to and highlight **FM Settings** and press the **Select button**.
3. **FM Channels** will be highlighted. If it is not highlighted, press ▼ to scroll to and highlight **FM Channels**. Press the **Select button**.
4. Press ▼ to scroll to and highlight the storage location (FM 1 to FM 5) you want to set and press the **Select button**. You can choose

FM Channels	
FM 1	97.9
FM 2	99.3 current
FM 3	100.3
FM 4	---
FM 5	---

among the following options:

- i. If the chosen storage location is empty (denoted by “---“), or if the storage location contains the FM preset currently being used (denoted by “current”), then the FM channel tuning screen is displayed.
- ii. If the chosen storage location has an FM preset that is not currently being used, and you want to edit it, **Edit Channel** is highlighted. Press the **Select button**. The FM channel tuning screen is displayed.
- iii. If the chosen storage location has an FM preset that is not currently being used, and you want to start using it, press ▲ to highlight **Start Using** and press the **Select button**. Skip to step 7.



5. Press ◀ and ▶ to tune to the desired FM channel in steps of .2, i.e., 99.3 to 99.5. Press ▼ and ▲ to tune to the desired channel in steps of 1, i.e., 99.3 to 100.3. Press the **Select button** to select the FM channel.
6. If you are editing the storage location that has the “current” FM preset, skip to step 7. Otherwise, **Start Using** will be highlighted. Press the **Select button**.



NOTE! You can also set an FM preset without having to start using it right away. Just press **Menu** and exit the screen.

7. The chosen FM channel will be confirmed on the display screen and Onyx EZR will tune to that FM channel.
8. Set your vehicle’s FM radio to same FM channel.



IMPORTANT! You’ll first need to find a suitable FM channel that is unused or available in your area.

To quickly select an FM preset:

1. Press **FM** to display the current FM preset.
2. To display and select the next FM preset, press **FM**. Onyx EZR will tune to the displayed FM channel. If the preset is the one you want, press **Menu** or wait for the screen to time out.
3. Repeatedly pressing **FM** will cycle through the FM presets.
4. Set your vehicle’s FM radio to same FM channel.

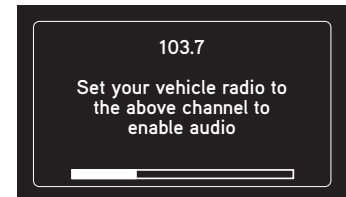

Turn the FM Transmitter On/Off

Turning the FM Transmitter On applies only if you are using the older model Vehicle Dock from the Universal Xpress Car Kit, and plan to use *SureConnect* or FM/DA as the audio connection option.

You'll have to turn On the FM Transmitter under the **FM Settings** menu. However, before you can access the **FM Settings** menu, you first need to disable AUX Detect. Refer to "AUX Detect" on page 37. Once you have disabled AUX Detect, the **FM Settings** menu will be accessible.

To turn the FM Transmitter On:

1. Press **Menu**.
2. Press ▼ to scroll to and highlight **FM Settings** and press the **Select button**.
3. **FM Transmitter** will be highlighted. Press the **Select button** to toggle the setting from Off to On.
4. The **FM Channels** menu item will now be accessible, allowing you to tune Onyx EZR and the FM radio in your vehicle to the same FM channel.



TIP! Onyx EZR is programmed with FM channel 97.9 as the default setting.

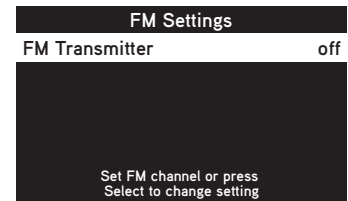

To turn the FM Transmitter Off:

If you are using the older model Vehicle Dock from the Universal Xpress Car Kit, and plan to use the Aux In Cable or a Cassette Adapter as the audio connection option, you'll have to turn the FM Transmitter under the **FM Settings** menu in Onyx EZR Off, if it was previously turned On.

1. Press **Menu**.
2. Press ▼ to scroll to and highlight **FM Settings** and press the **Select button**.
3. **FM Transmitter** will be highlighted. Press the **Select button** to toggle the setting from On to Off.
4. A warning message will be displayed advising you to connect the Aux In Cable. Press the **Select button** to confirm that you want to turn off the FM Transmitter.
5. Press and hold **Menu** to exit.

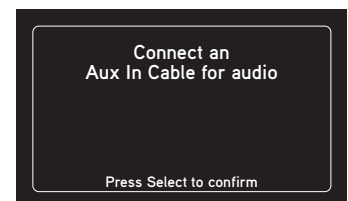

Jump Settings

The **Jump** button can be configured to jump back to the last channel to which you were listening to previous to the currently tuned channel (default), or jump to the traffic and weather for the city of your choice from a list of cities. When configuring for traffic/weather, you'll also need to select your city.

To configure Jump:

1. Press **Menu**.
2. Press ▼ to scroll to and highlight **Jump Settings** and press the **Select button**.
3. **Mode** will be highlighted with either **Last Channel** or **Traffic/Weather**. If you want to change the mode, press the **Select button**. Otherwise, just leave it as shown. (Repeatedly pressing the **Select button** toggles between the choices.)
4. If you have selected **Last Channel**, press and hold **Menu** to return to the main display screen. If you have selected **Traffic/Weather** continue with step 5.
5. Press ▼ to scroll to and highlight **Set Location** and press the **Select button**.
6. A list of cities will be displayed. Press ▼ to scroll to and highlight your desired location and press the **Select button**.
7. The **Jump Settings** screen will display the location you selected. Press and hold **Menu** to return to the main display screen.

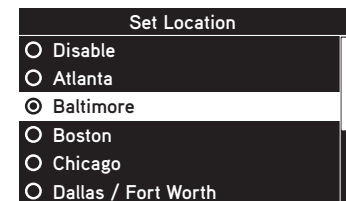
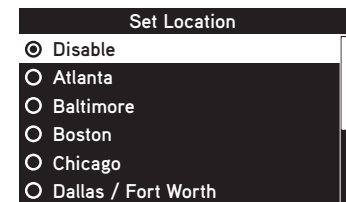
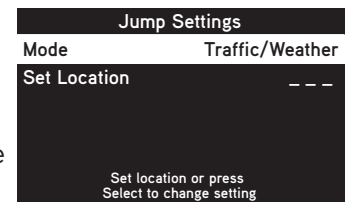
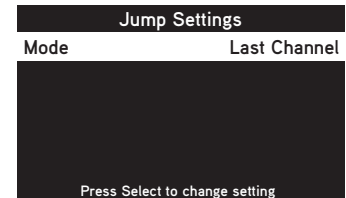

Display Settings

Display Settings allows you to change the mode of the display screen, to adjust the brightness of the display screen, and adjust the brightness of the buttons of Onyx EZR.

Display Screen

1. Press **Menu**.
2. Press ▼ to scroll to and highlight **Display Settings** and press the **Select button**.
3. **Display Screen** will be highlighted. Press the **Select button** to toggle the display screen between white/black and black/white.
4. Press and hold **Menu** to return to the main display screen.

White text on a black background

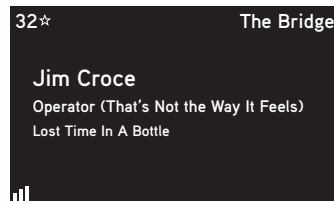

Black text on a white background

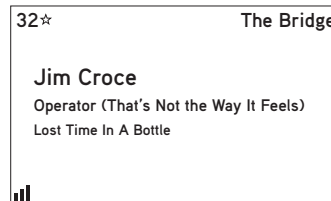

TIP! You can also change the display screen mode by pressing and holding the **Jump** button.

Screen Brightness

1. Press **Menu**.
2. Press ▼ to scroll to and highlight **Display Settings** and press the **Select button**.
3. Press ▼ to scroll to and highlight **Screen Brightness** and press the **Select button**.
4. Press ◀ to decrease or ▶ to increase the brightness of the display.
5. Press the **Select button** to confirm the brightness setting.
6. Press and hold **Menu** to return to the main display screen.

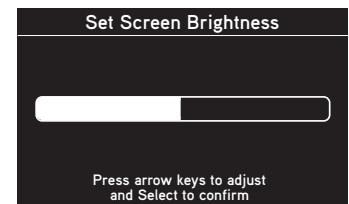

Button Brightness

1. Press **Menu**.
2. Press ▼ to scroll to and highlight **Display Settings** and press the **Select button**.
3. Press ▼ to scroll to and highlight **Button Brightness** and press the **Select button**.
4. Press ◀ to decrease or ▶ to increase the brightness of the buttons.
5. Press the **Select button** to confirm the brightness setting.
6. Press and hold **Menu** to return to the main display screen.

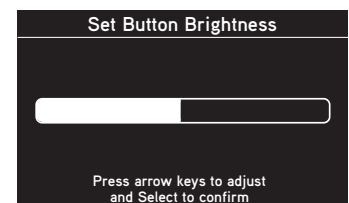

Feature Settings

Feature Settings allows you to adjust TuneMix, set the audible beep on/off, set the channel browsing auto select on/off, set text scrolling on/off, and erase all favorite channels.

TuneMix

Refer to “TuneMix” on page 26 for detailed information.

Audible Beep

Audible Beep turns on or off the beep that is heard when an advisory screen is displayed, or a traffic/weather report is tuned, etc.

1. Press **Menu**.
2. Press ▼ to scroll to and highlight **Feature Settings** and press the **Select button**.
3. Press ▼ to scroll to and highlight **Audible Beep**. Pressing the **Select button** will toggle between **On** and **Off**.
4. Press and hold **Menu** to return to the main display screen.

Channel Browsing Auto Select

Refer to “Automatically Tuning Channels in Categories” on page 20 for detailed information.

Text Scrolling

When an artist’s name or a song title is too long to be completely displayed on the display screen, the artist name and/or song title will scroll after a few seconds. This feature can be turned on or off as desired.

1. Press **Menu**.
2. Press ▼ to scroll to and highlight **Feature Settings** and press the **Select button**.
3. Press ▼ to scroll to and highlight **Text Scrolling**. Pressing the **Select button** will toggle between **On** and **Off**.
4. Press and hold **Menu** to return to the main display screen.

Erase all Favorite Channels

Refer to “Favorite Channels” on page 21 for detailed information.

Audio Level

The audio level of Onyx EZR can be adjusted when an audio connection is made between the dock and the vehicle's stereo system. Audio level is used to adjust Onyx EZR's volume level to match the volume of other audio sources you may use, such as a CD player, other FM stations, or an MP3 player.

Do not use the audio level as a volume control. Use the volume control on your vehicle's stereo instead.

To adjust the audio level:

1. Press **Menu**.
2. Press ▼ to scroll to and highlight **Audio Level** and press the **Select button**.
3. Press ◀ to decrease or ▶ to increase the audio level.
4. Press the **Select button** to confirm the new audio level.
5. Press and hold **Menu** to return to the main display screen.

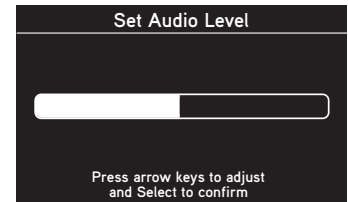

Parental Controls

Refer to “Parental Controls” on page 23 for detailed information.

Signal Indicator

For best reception, your Magnetic Mount Antenna should have an unobstructed view of the XM satellites. In large cities, there are terrestrial transmitters (ground repeaters) to help increase the signal coverage.

Your Onyx EZR can display the received strength of the satellite and terrestrial signals being received.

To display the signal strength:

1. Press **Menu**.
2. Press ▼ to scroll to and highlight **Signal Indicator** and press the **Select button**.
3. The Satellite and Terrestrial bars show the strength of the signal being received.
4. Reposition the antenna if you are having trouble receiving the signal. Be sure your vehicle is outside with an unobstructed view of the sky.
5. Press and hold **Menu** to return to the main display screen.

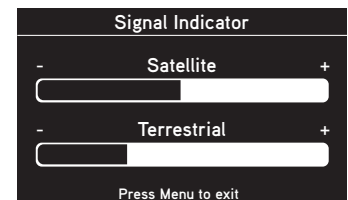

Auto Shut Off

Onyx EZR will automatically shut off after 8 hours of inactivity, i.e., when no buttons have been pressed. This feature prevents the vehicle battery from being discharged if you forget to turn your Onyx EZR off.

When Onyx EZR is about to shut off, an advisory will be displayed. If you wish to continue listening, press any button to cancel the auto shut off.

To enable or disable Auto Shut Off:

1. Press **Menu**.
2. Press ▼ to scroll to and highlight **Auto Shut Off** and press the **Select button**.
3. **Status** will be highlighted. Press the **Select button** to toggle between enabled or disabled for Auto Shut Off.
4. Press and hold **Menu** to return to the main display screen.

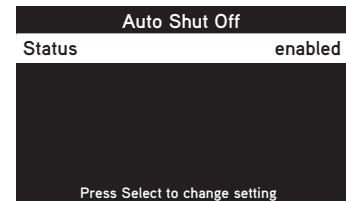

Factory Settings

The factory settings menu has two choices, **AUX Detect** and **Restore Defaults**.

AUX Detect

AUX Detect allows Onyx EZR to automatically detect a connection made to the **AUDIO** connector of the *PowerConnect* Vehicle Dock by an Aux In Cable or Cassette Adapter. AUX Detect is enabled by default.



IMPORTANT! If you are using the *PowerConnect* Vehicle Dock which came with your Onyx EZR, AUX Detect should remain enabled.

If you are using the older model Vehicle Dock from the Universal Xpress Car Kit, and plan to use *PowerConnect* or FM/DA as the audio connection option, you will need to disable AUX Detect. Once AUX Detect is disabled, you'll have to turn the FM Transmitter On. Refer to "Turn the FM Transmitter On/Off" on page 32.

To disable AUX Detect:

Do this only when using the older model Vehicle Dock.

1. Press **Menu**.
2. Press ▼ to scroll to and highlight **Factory Settings** and press the **Select button**.
3. **AUX Detect** should be highlighted and show as enabled. Press the **Select button** to toggle the setting.
4. An advisory screen will be displayed. Press the **Select button** to confirm that you want to disable AUX Detect, otherwise press **Menu**

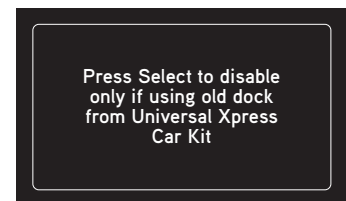
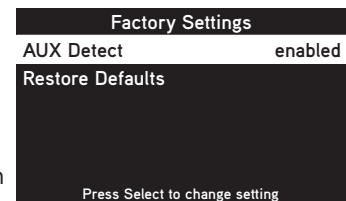

to cancel.

5. If you want to cancel press **Menu** to return to **Factory Settings**. AUX Detect will remain enabled.
6. AUX Detect will show as disabled. Press and hold **Menu** to return to the main display screen.

To enable AUX Detect:

Do this when the Radio is transferred to the *PowerConnect* Vehicle Dock from an older model Vehicle Dock.

1. Press **Menu**.
2. Press ▼ to scroll to and highlight **Factory Settings** and press the **Select button**.
3. **AUX Detect** will be highlighted and show as disabled. Press the **Select button** again to toggle the setting to enabled.
4. Press and hold **Menu** to return to the main display screen.

Restore Defaults

You can clear all of your personal settings, such as favorite channels, FM presets, etc., and return the Radio to its original out-of-the-box settings.

To reset Onyx EZR to factory defaults:



NOTE! Restoring defaults permanently removes all personal settings.

1. Press **Menu**.
2. Press ▼ to scroll to and highlight **Factory Settings** and press the **Select button**.
3. Press ▼ to scroll to and highlight **Restore Defaults** and press the **Select button**.
4. An advisory screen will be displayed. If you are certain that you want to reset your Onyx EZR to the default settings, press the **Select button** to confirm.
5. If you want to cancel, press **Menu** to return to **Factory Settings**.

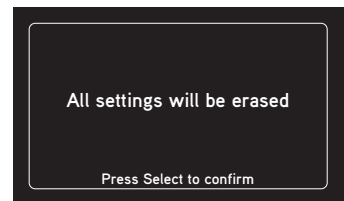

Demo Mode

Your Onyx EZR has a demo mode that starts playing when, for a prolonged period of time (more than 5 minutes), the Radio either detects it's not connected to the antenna, or the antenna stops receiving a signal. It disappears when the antenna is connected properly or when the Radio starts receiving a signal. You can also exit demo mode at any time, by pressing and holding the **Select button** for 10 seconds. If desired, you can also manually put Onyx EZR in demo mode.

The ability for Onyx EZR to enter demo mode is enabled by default. If you don't want Onyx EZR to ever enter the demo mode, you can disable the demo feature. You can enable it again at another time if desired.

To enable or disable the demo mode:

1. Press **Menu**.
2. Press ▼ to scroll to and highlight **Demo Mode** and press the **Select button**.
3. **Status** will be highlighted. Press the **Select button** to toggle the setting between enabled or disabled. (Repeatedly pressing the **Select button** toggles between the choices.)
4. If you have selected disabled, press and hold **Menu** to return to the main display screen. If you have selected enabled continue with step 5.
5. Press ▼ to scroll to and highlight **Enter Demo Mode** and press the **Select button**. The demo mode will start in 10 seconds.
6. To exit demo mode at any time, press and hold the **Select button** for 10 seconds.

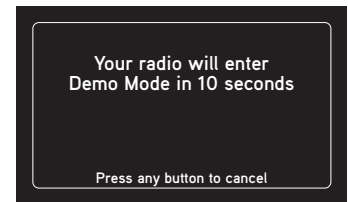
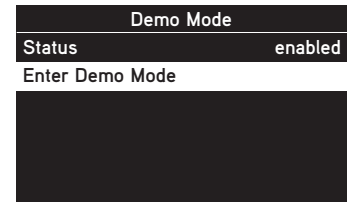

Onyx EZR has been designed and built to be trouble-free but if you experience a problem, try this:

- Check that all connections are firm and secure.
- Make sure you have connected the Home Dock as described in this User Guide. Verify that the AC power outlet is working.

If you see this on the screen:	Try this:
Acquiring Signal	<ul style="list-style-type: none"> • Move the antenna to a south-facing window. Not sure which way is south? Think about where the sun rises (in the east) and sets (in the west). Then stand so that east is to your left and you'll be facing south. Is there a window in the direction you're facing? • You may need to find a better location for the antenna. Refer to "Step 2: Place and Aim the Indoor/Outdoor Home Antenna" on page 11.
Check Antenna Connection	<ul style="list-style-type: none"> • Make sure that the antenna cable is firmly and securely plugged into the Home Dock. Make sure the cable is not bent or broken. • Turn Onyx EZR Off, then On, to reset this message. • If the message persists, most likely the Indoor/Outdoor Home Antenna cable has been damaged. Replace the antenna.
Channel Off Air	<ul style="list-style-type: none"> • The channel you've selected is not currently broadcasting. Tune to another channel.
Loading	<ul style="list-style-type: none"> • Your Onyx EZR is acquiring audio or program information. This message usually goes away in a few seconds.
Updating	<ul style="list-style-type: none"> • Your Onyx EZR is updating with the latest encryption code. Wait until the update is done. • You may be trying to tune to a channel that is blocked or unavailable. Tune to another channel.
—	<ul style="list-style-type: none"> • No program information, such as artist name, song title, or channel exists.
If this happens:	Try this:
You do not receive all the channels to which you subscribed	<ul style="list-style-type: none"> • Ensure that you have subscribed to the service by following the steps in "Step 4: Activate" on page 15. • Go to www.siriusxm.com/refresh and follow the directions to refresh your Radio. • Call 1-866-635-2349 for further assistance.
Audio sounds too soft	<ul style="list-style-type: none"> • Raise the volume of your stereo system or increase the audio level of your Onyx EZR until the sound quality improves. Refer to "Audio Level" on page 36.
Audio fades or has static when listening	<ul style="list-style-type: none"> • Check all cables for a firm and secure connection.
No audio	<ul style="list-style-type: none"> • Check all cables between Onyx EZR and your stereo system or powered speakers for a firm and secure connection. • Ensure you have selected the proper input source on your stereo system, or try another source. • Increase the audio level of Onyx EZR. Refer to "Audio Level" on page 36.

If this happens:	Try this:
No song title or artist name is displayed	<ul style="list-style-type: none">• The information may not be available or updates may be in progress.
Traffic and Weather channels sound different from other channels	<ul style="list-style-type: none">• These channels use a different audio technology than other channels so they often sound different from other channels.
The demo is playing	<ul style="list-style-type: none">• The Indoor/Outdoor Home Antenna is not connected or you are not receiving the XM signal. Check that the antenna is connected properly and is not obstructed.• Press and hold the Select button for 10 seconds to exit Demo Mode.• You can disable Demo Mode. Refer to “Demo Mode” on page 38.

Patent Information

It is prohibited to, and you agree that you will not, copy, decompile, disassemble, reverse engineer, hack, manipulate, or otherwise access and/or make available any technology incorporated in this product. Furthermore, the AMBE® voice compression software included in this product is protected by intellectual property rights including patent rights, copyrights, and trade secrets of Digital Voice Systems, Inc. The software is licensed solely for use within this product. The music, talk, news, entertainment, data, and other content on the Services are protected by copyright and other intellectual property laws and all ownership rights remain with the respective content and data service providers. You are prohibited from any export of the content and/or data (or derivative thereof) except in compliance with applicable export laws, rules and regulations. The user of this or any other software contained in a Sirius XM Radio Inc is explicitly prohibited from attempting to copy, decompile, reverse engineer, hack, manipulate or disassemble the object code, or in any other way convert the object code into human-readable form.

Environmental Information

Follow local guidelines for waste disposal when discarding packaging and electronic appliances.

Perchlorate Material - special handling may apply. See www.dtsc.ca.gov/hazardouswaste/perchlorate (Applicable to California, U.S.A.)

The user is cautioned that changes or modifications not expressly approved by Sirius XM Radio Inc. can void the user's authority to operate this device.

This device complies with Part 15 of the FCC Rules. Operation is subject to the following two conditions:

1. This device may not cause harmful interference.
2. This device must accept any interference received, including interference that may cause undesired operation.

This equipment has been tested and found to comply with the limits for a Class B digital device, pursuant to Part 15 of the FCC Rules. These limits are designed to provide reasonable protection against harmful interference in a residential installation.

This equipment generates, uses, and can radiate radio frequency energy and, if not installed and used in accordance with the installation instructions, may cause harmful interference to radio communications. However, there is no guarantee that interference will not occur in a particular installation. If this equipment does cause harmful interference to radio or television reception, which can be determined by turning the equipment off and on, the user is encouraged to try to correct the interference by one or more of the following measures:

- Reorient or relocate the receiving antenna of the affected receiver.
- Increase the separation between the SiriusXM equipment and the affected receiver.
- Connect the SiriusXM equipment into an outlet on a circuit different from that to which the affected receiver is connected.
- Consult the dealer or an experienced radio/TV technician for help.

WARNING! The FCC and FAA have not certified this Satellite Radio Receiver for use in any aircraft (neither portable nor permanent installation). Therefore, Sirius XM Radio Inc. cannot support this type of application or installation.

IMPORTANT NOTICE: REQUIRED SUBSCRIPTION

Hardware and subscription sold separately, and activation fee required. Other fees and taxes may apply. **Subscriptions governed by SiriusXM Customer Agreement; see www.siriusxm.com. Service automatically renews into the subscription Package you choose (which may differ from the Package which arrived with the Radio), for additional periods of the same length, and automatically bills at then-current rates, after any complimentary trial or promotional period ends. You must call us to cancel at 1-866-635-2349.** Fees and programming are subject to change.

© 2017 Sirius XM Radio Inc. “Sirius”, “XM” and all related marks and logos are trademarks of Sirius XM Radio Inc. and its subsidiaries. All other marks and logos are the property of their respective owners. All rights reserved. Certain features depend on subscription package.

WARNING: This product contains chemicals known to the State of California to cause cancer and birth defects or other reproductive harm.

The Radio model number is located below and the XM Radio ID is located on the label on the back of Onyx EZR.

Record the XM Radio ID in the space provided below. Refer to these numbers whenever you call your dealer regarding this product.

Radio Model Number: SXEZR1H1

XM Radio ID: _____

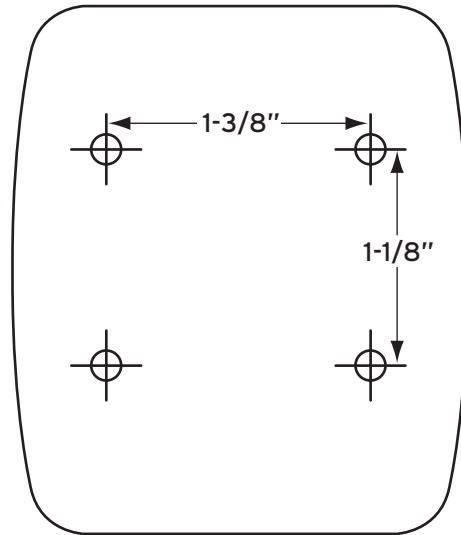

**Sirius XM Radio Inc.
1221 Avenue of the Americas
New York, NY 10020
1.866.635.2349**

siriusxm.com