

TECHNICAL MANUAL

Please Read
Before Installation

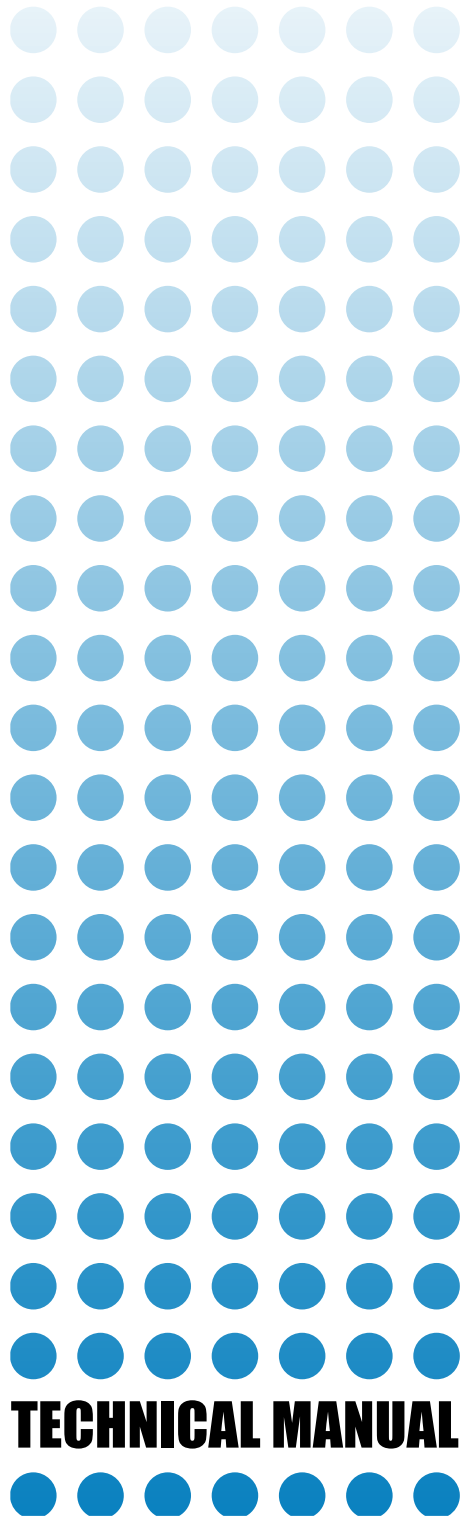

COMBO™

Hard Drive Player C400



Contents

Using this Manual	3
Read These Instructions.....	5
Safety Precautions.....	5
Installing Combo	5
Unit Functions	7
Unit Operation.....	7
Power & Standby.....	7
Content Updates	8
Display	8
Buttons.....	9
Menu Functions.....	9
Software Updates.....	13
Compliance.....	13
Cleaning and Maintenance	14
System Troubleshooting	14
Safety Precautions for Service Personnel	14
Unit Warranty.....	14

Using this Manual

This document serves as a guide for the safe installation of PlayNetwork's Combo™ C400 music player. Before installing and operating the Combo player, please read all of the following safety and operating instructions carefully and completely.

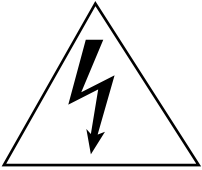
Keep this manual in a safe place for future reference. Questions or comments may be submitted anytime toll free by calling 1-888-567-PLAY (7529).

	CAUTION	
WATCH FOR THESE SYMBOLS		
CAUTION: TO REDUCE THE RISK OF ELECTRIC SHOCK, DO NOT REMOVE COVER. NO USER-SERVICEABLE PARTS INSIDE. REFER SERVICE TO QUALIFIED SERVICE PERSONNEL.		

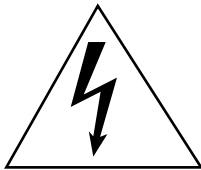

Lightning Bolt Symbol:

This symbol is used to alert the user to the presence of dangerous voltages and the possible risk of electric shock.



Exclamation Mark Symbol:

This symbol is used to alert the user to make a special note of important operating or maintenance instructions found in the reference manual.

WARNING: TO REDUCE THE RISK OF FIRE OR ELECTRIC SHOCK DO NOT USE THIS APPARATUS NEAR WATER.

COMBO™ C400 HARD DRIVE PLAYER FEATURES AND CONTROLS

Front View:



- A. Power/Standby Button
- B. Shortcut Keys
- C. CD-ROM Drive
- D. Navigation Buttons
- E. Power On Indicator
- F. LCD Display
- G. CD-ROM Disc Load/Eject

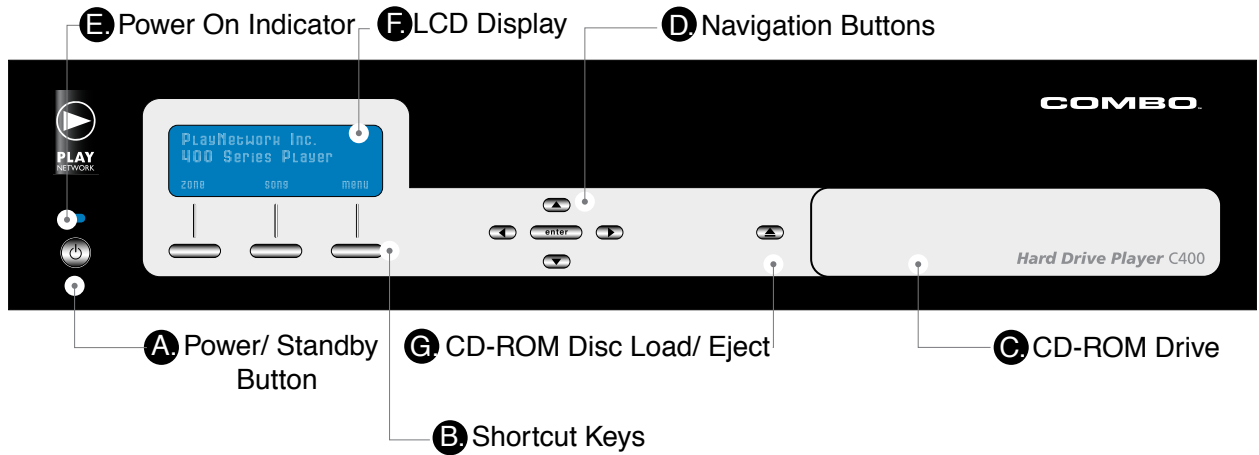

Back View:



- H. Power Inlet
- I. Zone 1 Output
- J. Zone 2 Output
- K. Network Connector
- L. Modem Connector
- M. Digital Audio Output
- N. Line Output

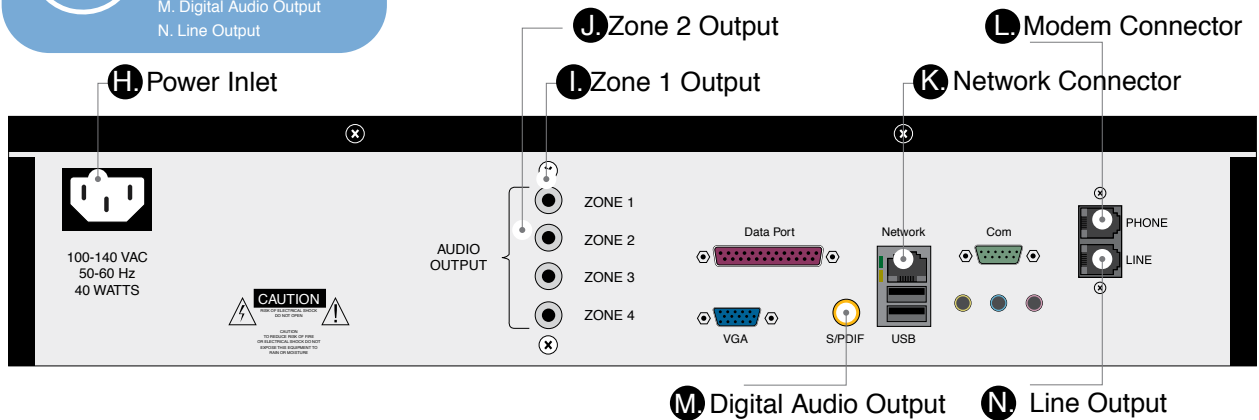

Read These Instructions

Safety Precautions:



- Read, follow, and keep these instructions. Heed all warnings.
- Only use attachments/accessories specified by the manufacturer.
- Do not block any of the ventilation openings. Never push objects of any kind into the Combo player through the cover ventilation slots, as they may touch dangerous voltage points or short-out parts that could result in a fire or electric shock. Should anything fall into the cover, unplug the unit and have it checked by a qualified PlayNetwork technician before operating it further.
- Do not install near any heat sources such as radiators, heat registers, stoves, or other apparatuses that produce heat.
- Do not defeat the safety purpose of the grounding type plug. A grounding type plug has two blades and a third grounding prong. The third prong is provided for your safety. When the provided plug does not fit into your outlet, consult an electrician for replacement of the obsolete outlet.
- Unplug the Combo player from its power source before cleaning. Clean only with a dry cloth. Do not use any type of solvent cleaner such as alcohol or mineral spirits.
- Unplug the Combo player during lightning storms or when unused for long periods of time.
- Protect the power cord from being walked on or pinched, particularly at plugs, convenience receptacles, and the point where they exit from the apparatus.

Installing Combo

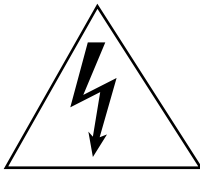

CAUTION: TO AVOID ELECTRIC SHOCK, FIRE OR FAILURE, Combo must be installed in a clean, dry location where it will not come into contact with water or moisture. DO NOT USE THIS APPARATUS NEAR WATER.

- Place the Combo player on a level, stable surface. All four feet must be securely seated on the mounting surface.
- Do not disconnect cables from audio components (including Combo) while power is on.
- Plug the Combo player's power cord into the same power strip your sound system is plugged into. Use only 120VAC 60 Hz power.
- If needed, use only with brackets specified by the manufacturer, or sold with the apparatus.



Note: For players connected to the network THE PLAYER MUST BE POWERED OR IN STANDBY EACH NIGHT in order to receive scheduled nightly content updates.

Note: ALWAYS POWER OFF YOUR AMPLIFIER BEFORE CONNECTING THE COMBO PLAYER. Also be sure to verify that Combo is turned OFF and that your amplifier equipment is turned down to its minimum volume setting before connecting.

- Analog Audio - Connect an audio cable to the “Zone 1” RCA audio output on the back of the Combo player. Connect the opposite end of the cable to your amplifier equipment. Repeat these steps for “Zone 2” if a second zone is required. Refer to the plug-and-play diagram provided by PlayNetwork if available.
- If content is to be delivered via network, connect a RJ45 network cable to the connector into the back of player and connect the other end to your network access point (router, hub or wall port).
- If content is to be delivered via modem, connect a telephone cable to the modem connector into the back of player. If needed, connect a phone to the second modem connector.
- Power up the Combo player by pushing the Power Button on the front panel. The Combo player will initialize and play music and other programmed content from its hard drive within 2 minutes. Adjust the volume of your amplifier equipment to the desired listening level.
- Do not stack non-PlayNetwork objects on top of player as this may impede proper heat ventilation of the Combo player. Leave at least six inches of clearance on both sides of the unit for adequate ventilation.
- Keep the Combo player free of dust, grease and dirt.

Unit Functions

The Combo C400 player is a digital-quality hard-drive based player with single- or dual-zone playback technology that features the following functions:

- “Hands-free” media content for 24-hours a day, 7 days a week. The Combo player will automatically begin play upon power-up and will continue playback until the unit is powered down or placed in standby. This AutoPlay technology assures that appropriate music styles and tempos are automatically selected and played throughout the day.
- The Combo player automatically shuffles songs within programmed dayparts from the hard drive to create a randomized order or playlist.
- The Combo player displays Now Playing information (Program, Title and Artist names) for song or messages currently being played and recently played songs.
- The Combo player provides means for controlling the basic playback of songs, programs, and playlists.
- Capable of playing all PlayNetwork disc formats.
- The Combo player provides function keys to access maintenance related functions such as setting the time and date.

Unit Operation

Power & Standby

The Combo player is a computer device requiring approximately 2 minutes to initialize upon power-up via the power button. Power is indicated via the Power LED located on the left side of the front panel. After initialization, the Combo player will automatically load AutoPlay programming from the hard drive and begin playing music.

The Combo player can be placed in Standby mode by pressing the power button once. While in Standby mode, audio playback is stopped for all zones and the Status Display indicates the unit is sleeping. Standby mode is recommended for customers using network delivery of content since the unit can still receive content updates to ensure prompt delivery of network song and scheduling updates.

The Combo player can also be powered down by pressing the power button twice. After confirmation, the unit will power down. Note: Players connected to the network should not be powered down as this prevents content updates to be delivered via the network connection.

Content Updates

Hard Drive Update

For customers using a wide area network (Ethernet connection) for content updates, the updates are delivered to players automatically as long the player is powered and plugged into the network during scheduled update time periods.

For customers receiving CD-ROM content updates, load a PlayNetwork CD-ROM disc by pressing the Disk Load/Unload Button and place the disc in the tray (printed side face up), and press the button again. The player will process the CD-ROM, loading content on to the hard drive and will eject the CD within 5 to 10 minutes depending on the amount of content found on the disc.

Note: Expired CD-ROMs or non-PlayNetwork discs are automatically ejected.

The Combo player will only work with authorized PlayNetwork CD-ROM load discs. PlayNetwork CD-ROM discs are intended only for use with PlayNetwork's players and will not work with components manufactured by other companies.

Each playlist is programmed to "expire" after a fixed amount of time.

CD Richmix / CD PlayDisc Update

Load a PlayNetwork CD-Rom disc by pressing the Disc Load / Unload Button and place the disc in the tray (printed side face up), and press the button again. The player will process the CD-Rom and begin to play music within 30 seconds.

Note: Expired CD-ROMs or non-PlayNetwork discs are automatically ejected.

Each Playlist is programmed to "expire" after a fixed amount of time.

Display

The Combo player comes equipped with a four-line, 20-character LCD display used to show status and enable control of the playback.

The display has four main modes: Initialization, Now Playing, Menu and Standby.

- **Initialization Mode** — Upon power up, the player will enter an Initialization mode for 45 to 90 seconds.
- **Now Playing Mode** — Once the player begins playing content, the display will enter a "Now Playing" mode showing Program Name, Title and Artist information for the currently playing song or message on Zone 1, the default zone after power up. This is the default display mode for the player and with the exception of two situations described below the display returns to this mode when no user interaction occurs for 60 seconds.

NOTE: If no Title and Artist information is shown on the Now Playing display, the zone's playlist is either expired or invalid. If content modification is enabled for your location, use the View Playlist menu item described below to select a new valid playlist. If no playlist is available, notify PlayNetwork's Customer Service department as directed on the last page of this document.

- **Menu Mode** — The display enters Menu mode in two ways. The Quick Menu, which contains a list of the most commonly used features, is entered when the "QMenu" shortcut key on the Now Playing display is pressed. The Main Menu, which contains a complete list of player menu options, is entered by pressing any of the navigation keys while on the main display or by selecting the "Main Menu" item on the Quick Menu.

Buttons

The Combo player has the following button groups to control operation:

- Power/Standby – This button can be used to power up the unit, put it in standby, or power it down.
- Navigation & Enter
 - During normal operation, pressing any of the navigation buttons will bring the Main Menu to the display.
 - During menu operations, these buttons can be used to navigate the menus as follows:
 - Scrolling up and down menu items
 - Entering sub menus
 - Selecting the highlighted menu item
 - Returning to the previous menu
- Shortcut Keys – These buttons, located immediately below the display, provide quick access to key functions as well as a means to initiate the Quick Menu. The functions displayed depend on the contents of the display itself.
- Disk Load/Eject – This button is used to open and close the the CD tray.

Menu Functions

The Combo player maintains two menus to provide efficient access to player features. The Quick Menu, contains a list of the most commonly used features and it can be entered by pressing the “QMenu” shortcut key on the Now Playing display. The Main Menu, contains a complete list of player menu options and it is entered by pressing any of the navigation keys while on the main display or by selecting the “Main Menu” item on the Quick Menu.

With the exception of a few special menus, Menu mode will timeout and resume Now Playing mode after 60 seconds with no button interaction.

The following are the menus, submenus and menu items in the two system menus.

Quick Menu

Last 5 Tracks
Resume Program
Next Program
View/Select Program
Restart Playlist
Main Menu
Help

Main Menu

Tracks
Programs
Playlists
Help
Diagnostics Info
Setup

Next Zone

The Combo player has the ability to play unique music for one or two zones. For players that have more than one zone enabled, information about each zone can be viewed on the display once the zone has been selected by pressing the “Zone+” shortcut button on the Now Playing display.

Skip

Song advance can be enabled or disabled for each business location for a single store zone, depending on your service contract with PlayNetwork. If the feature is enabled for your location, when in Now Playing mode, advance or skip to the next song in the playlist by pressing the center shortcut button labeled “Skip”.

Program Advance

Program advance can be enabled or disabled for each business location for a single store zone, depending on your service contract with PlayNetwork. If the feature is enabled for your location, you can override the normal programming in the displayed zone and advance to the next program in the playlist by selecting Next Program from either menu. If there is only one program available, the Program Advance menu item will notify the user.

When a Program Advance is selected, the currently playing song or message will be stopped and a new song or message from the selected program will begin to play. The selected program will play until completion or until the end of the next time-based daypart — whichever comes first. In addition, normal programming can also be resumed by selecting Resume Normal Programming from either menu.

View Tracks

To view the Title and Artist of the songs or messages in the current playlist, select the View Tracks menu item. Use the Up/Down buttons to navigate through the song list. To play the displayed song, press the Enter or “>”.

Last 5 Tracks

To view the Title and Artist of the last 5 songs or messages, select the Last 5 Tracks menu item on the Quick Menu and use Up/Down buttons to navigate through the song list. To play the displayed song, press Enter or “>”.

View/Select Programs

To view the list of Programs in the current playlist, select the View/Select Programs menu item from either menu. Use the Up/Down buttons to navigate through the program list.

If content modification is enabled for the currently playing content, press the Enter or “>” button to override the currently playing content and play the displayed program. When a new program is selected, the currently playing song or message will be stopped and a new song or message from the selected program will begin to play. If content modification is not enabled, a message will be displayed indicating this action is not available.

Once the selected program has completed playback or as soon as the end of the next time-based daypart is reached — whichever comes first — the normal programming schedule will resume. Normal programming can also be resumed by selecting Resume Normal Programming from either menu.

View Playlist

This feature is only available when playlist content modification is enabled per the service contract with PlayNetwork.

To view the list of playlists available for selection, select the View Playlists menu item on the Main Menu. Use the Up/Down buttons to navigate through the list of playlists and select the highlighted playlist by pressing the ENTER or ">" button. When a new playlist is selected, the currently playing song or message will be stopped and a new song or message from the selected playlist will begin to play.

Restart Playlist

The Combo player provides the ability to restart the current playlist for the displayed zone. When this feature is selected, the currently playing song or message will be stopped and a new song or message from the current playlist will begin to play.

View/Set Time

The Combo player provides the ability to set the Time to support time-based programming needs. Time is set by selecting the View/Set Time menu item from the Main Menu's Setup list and entering the desired hour, minutes and AM/PM setting.

If your location's programming utilizes time-based dayparts, it will be necessary to reset the local time after Daylight Savings Time for your area.

View/Set Date

To view the date currently set on the Combo player, select the View/Set Date Main Menu's Setup list. To change the date you must insert a Set Date Disc from PlayNetwork into the player and set the date within the allowed range. If you do not have a Set Date Disc, call your local dealer or Customer Service as directed on the last page of this document to request one.

View Info Messages

View messages containing management information such as newly received content updates by selecting the Info Messages in the Help menu of the Main Menu and scroll through the list of displayed messages.

Player Info/Version

View detailed player information including the serial number, software version and total uptime by selecting Diagnostics from the Main Menu, and scroll down through the player information.

Troubleshooting

The Combo player has a short set of troubleshooting steps built into for basic trouble shooting when the player does not function as expected. Access these troubleshooting steps by selecting Troubleshooting from either menu's Help list.

If unsuccessful after trying the recommended steps, give PlayNetwork's Customer Service a call by selecting "Customer Service" from either menu. The phone number remains displayed until the ENTER, "<" or "BACK" button is pressed.

View Customer Service Info

The Combo player displays PlayNetwork's Customer Service telephone number as a ready reference should problems arise. Locate the phone number by selecting Help from either menu. The phone number remains displayed until the ENTER, "<" or "BACK" button is pressed.

View Info Messages

The Combo player allows the user to view messages containing management information such as newly received content updates. To view the most recently received messages, select the Main Menu's Info Messages item, and scroll through the list of displayed messages.

Player Info/Version

The Combo player provides the ability to display detailed player information including the serial number, software version and total uptime. To access this information, select "Diagnostics" from the Main Menu, select Player Info/Version and scroll down through the player information.

Troubleshooting

The Combo player has a short set of troubleshooting steps built in to try to when the player does not function as expected. To access these troubleshooting steps, select "Troubleshooting" from either menu's Help list.

After trying the recommended steps, give PlayNetwork's Customer Service a call by selecting "Customer Service" from either Menu's Help list to display the phone number. This display will remain until the ENTER, "<" or "BACK" button is pressed.

View Customer Service Info

The Combo player displays PlayNetwork's Customer Service telephone number as a ready reference should problems arise. To view the phone number, select "Customer Service" from either Menu's Help list. This display will remain until the ENTER, "<" or "BACK" button is pressed.

Software Updates

For customers using a wide area network for content updates, software updates are delivered to players automatically. Note: The player must be powered and connected to the network during scheduled update time periods for this to occur.

For customers receiving CD-ROMs for content updates, software updates can be delivered as part of the content update discs or upon occasion as a standalone Software Update disc.

For standalone updates, load the PlayNetwork Software Update CD-ROM disc by pressing the Disc Load/Eject button and place the disc in the tray (label side up), and press the button again to load the CD. The player will process the CD, loading the software into the player and will eject the CD within a minute.

Display the player's software version by selecting Diagnostics from the Main Menu and scroll through the player information.

Compliance

The Combo player complies with the following regulatory and certification requirements:

FCC

This equipment has been tested and found to comply with the limits for a Class A digital device, pursuant to part 15 of the FCC Rules. These limits are designed to provide reasonable protection against harmful interference when the equipment is operated in a commercial environment. This equipment generates, uses, and can radiate radio frequency energy and, if not installed and used in accordance with the instruction manual, may cause harmful interference to radio communications. Operation of this equipment in a residential area is likely to cause harmful interference in which case the user will be required to correct the interference at their own expense.

Modifications not expressly approved by the manufacturer could void the user's authority to operate the equipment under FCC rules.

The modem contained in this equipment complies with Part 68 of the FCC rules and the requirements adopted by the Acta. The product identifier of this modem is US02E0010-E. If requested, this number must be provided to the telephone company.

Cleaning and Maintenance

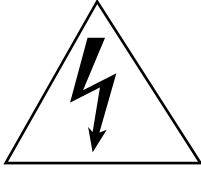

CAUTION: TO REDUCE THE RISK OF ELECTRIC SHOCK, DO NOT REMOVE COVER. THERE ARE NO USER-SERVICEABLE PARTS INSIDE. REFER SERVICE TO QUALIFIED SERVICE PERSONNEL.

The Combo player should be maintained in a clean, dry location that is free from dust, grease and other particles. Wipe unit frequently with a clean, dry, non-abrasive cloth. DO NOT COVER UNIT.

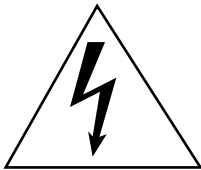

CAUTION: TO REDUCE THE RISK OF FIRE OR ELECTRIC SHOCK DO NOT EXPOSE THIS EQUIPMENT TO RAIN OR MOISTURE.

System Troubleshooting

- Check all connections.
- If interruption in the play program occurs, turn off power to unit, wait 30 seconds and turn power back on. This will “restart” the unit and should correct any problems. If problem persists or intermittently occurs often, call PlayNetwork Customer Service. DO NOT REMOVE UNIT COVER.

Safety Precautions for Service Personnel:



CAUTION: REFER ALL SERVICING TO QUALIFIED SERVICE PERSONNEL. Servicing is required when the apparatus has been damaged in any way; such as, power supply cord or plug is damaged, liquid has been spilled or objects have fallen into apparatus, the apparatus has been exposed to rain or moisture, does not operate normally, or has been dropped.

Unit Warranty

The Combo player is covered under a limited, one-year warranty. This warranty is valid only if an authorized PlayNetwork technician performs service. Please refer to your Music Service Agreement for details.

PlayNetwork Customer Service

Locate the Customer Service number by selecting Help from either menu. The phone number remains displayed until the “ENTER”, “<”, or “BACK” button is pressed.

You can also reach Customer Service M-F between 7a-5p (Pacific) and Saturday 8a-12p (Pacific), or questions or comments may be submitted anytime (24 hours a day), toll free, by calling:

1-888-567-PLAY (7529)

© 2009 PlayNetwork Inc. All rights reserved.
Combo and AutoPlay are trademarks and PlayNetwork and the
PlayNetwork logo are registered trademarks of PlayNetwork Inc. or
its affiliates in the U.S. and certain other countries. All other
trademarks mentioned in this document are the property of their
respective owners. (0403R)

PLAC400MANUAL



DRIVE YOUR BRAND. EXTEND YOUR REACH. **JUST PUSH PLAY.**

8727 148TH AVE., NE. REDMOND WA 98052 1.888.567.7529 www.playnetwork.com